

Gigaset

SL910H

Congratulations

By purchasing a Gigaset, you have chosen a brand that is fully committed to sustainability. This product's packaging is eco-friendly!

To learn more, visit www.gigaset.com.



GIGASET. INSPIRING CONVERSATION.
MADE IN GERMANY

Gigaset SL910H – with the special "touch"

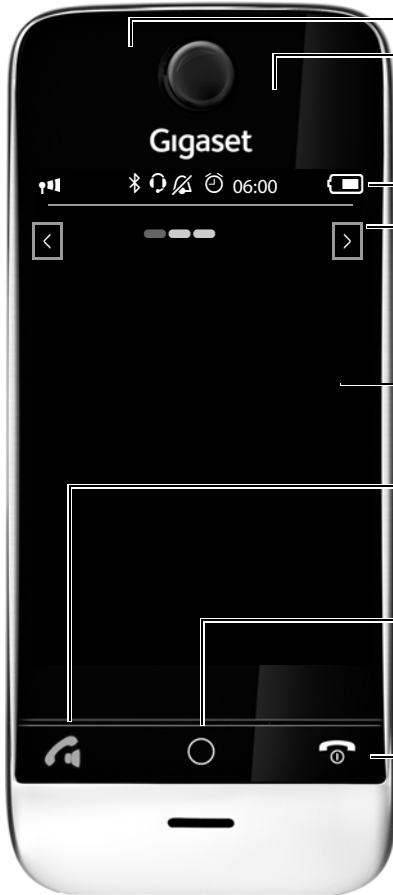

Message LED (→ page 10)

Proximity sensor (→ page 14)

Touchscreen/display

Status bar (→ page 12)

Icons (→ page 45) show the telephone's current settings and operating status. Touch the status bar to open the → status page, page 12.

Navigation area

Page position marker ,
Change page .

Idle displays or menu (→ page 8)

Handset keys

Talk key

Press **briefly**: Dial displayed number, accept call, switch between earpiece and handsfree mode, open the redial list
Press and **hold**: assign a line

Menu key

Press **briefly**: open main menus (→ page 13)
Press and **hold**: activate/deactivate (→ page 14) keypad and display lock

End call/end key

Press **briefly**: end call/paging, reject internal call, switch off ring tone for external call, return to idle status
Press and **hold**: switch handset on/off



Mini USB connection socket

Connect wire-bound headset or handset to your PC (Gigaset QuickSync)

Charging contacts

Please note

To change the display language, proceed as described on page **page 23**.

Contents

Gigaset SL910H – with the special "touch"	1
Safety precautions	3
Getting started	4
Display pages	8
Using the telephone	14
Making calls	19
Changing phone settings	23
ECO DECT	26
Network mailbox	27
Multiple handsets	28
Bluetooth devices	30
Contacts (address book)	33
Calls list (dependent on base)	38
Calendar	39
Alarm	40
Baby phone call	41
Screensaver, caller pictures and sounds	42
Synchronising with your PC (Gigaset QuickSync)	43
Display icons	44
Setting options (depending on the base)	46
Customer Service & Assistance	49
Environment	52
Appendix	53
Open Source software	55
Index	63

Safety precautions

Warning

Read the safety precautions and the user guide before use.
Explain their content and the potential hazards associated with using the device to your children.



Use only the power adapter indicated on the device.



Use only **rechargeable batteries** that correspond to the **specification** (see "Technical Data"). Never use a conventional (non-rechargeable) battery or other battery types as this could result in significant health risks and personal injury. Rechargeable batteries, which are noticeably damaged, must be replaced.



Using your telephone may affect nearby medical equipment. Be aware of the technical conditions in your particular environment, e.g., doctor's surgery. If you use a medical device (e.g., a pacemaker), please contact the device manufacturer. They will be able to advise you regarding the susceptibility of the device to external sources of high frequency energy (for the specifications of your Gigaset product see "Technical Data").



Do not hold the rear of the handset to your ear when it is ringing or when speaker mode is activated. Otherwise you risk serious and permanent damage to your hearing.

Your Gigaset is compatible with the majority of digital hearing aids on the market. However, perfect function with all hearing aids cannot be guaranteed.

The phone may cause interference in analogue hearing aids (humming or whistling) or cause them to overload. If you require assistance, please contact the hearing aid supplier.



The devices are not splashproof. For this reason do not install them in a damp environment such as bathrooms or shower rooms.



Do not use the devices in environments with a potential explosion hazard (e.g., paint shops).



If you give your Gigaset to a third party, make sure you also give them the user guide.



Remove faulty devices from use or have them repaired by our Service team, as these could interfere with other wireless services.

Please note

- The device cannot be used in the event of a power failure. It is also **not** possible to transmit **emergency calls**.
- Emergency numbers cannot be dialled if the keypad lock is activated!

Getting started

Checking the package contents

- ◆ One Gigaset **handset**
- ◆ One battery cover (rear cover for the handset)
- ◆ One battery
- ◆ One **charger cradle**
- ◆ One power adapter for the charger cradle
- ◆ One user guide.

Charger cradle

The charger cradle is designed for use in dry rooms in a temperature range of +5°C to +45°C.

- ▶ Set up the charger cradle on a flat, non-slip surface.

Please note

Pay attention to the range of the base. In buildings this is up to 50 m, outdoors up to 300 m. The range is reduced when ECO DECT (→ [page 26](#)) is activated.

The phone's feet do not usually leave any marks on surfaces. However, due to the multitude of different varnishes and polishes used on today's furnishings, the occurrence of marks on the surfaces cannot be completely ruled out.

Please note:

- ◆ Never expose the telephone to the effects of heat sources, direct sunlight or other electrical devices.
- ◆ Protect your Gigaset from moisture, dust, corrosive liquids and fumes.

Connecting the charger cradle

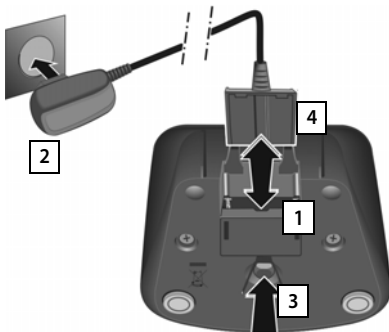

- ▶ Connect the flat plug to the power adapter [1].
- ▶ Plug the power adapter into the plug socket [2].

If you have to remove the plug from the charger cradle again:

- ▶ First disconnect the power adapter from the mains power supply.
- ▶ Then press the release button [3] and disconnect the plug [4].

Setting up the handset for use

The handset's display and keys are covered with a protective film.

Please remove the protective film.

Caution

Please do **not** use any touchscreen styli to operate the handset.

Do not use protective cover/film from other manufacturers. This can restrict operability of your handset.

Inserting the battery and closing the battery cover

Caution

Use only rechargeable batteries (→ [page 53](#)) recommended by Gigaset Communications GmbH, as doing otherwise could result in significant health risks and personal injury. For example, the outer casing of the battery could be destroyed or the battery could explode. The phone could also malfunction or be damaged as a result of using batteries that are not of the recommended type.

- ▶ First, insert battery with the contact surface facing down **1**.
- ▶ Then press the battery downwards **2** until it clicks into place.

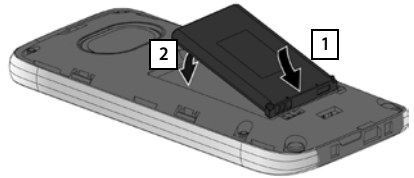

- ▶ First, align the protrusions on the side of the battery cover with the notches on the inside of the casing.
- ▶ Then press the cover until it clicks into place.

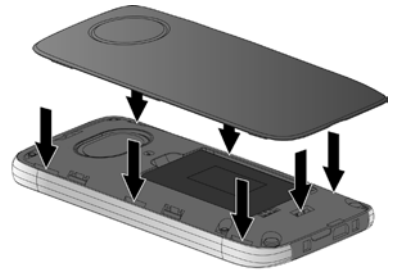

To **reopen the battery cover** to replace the battery:

- ▶ Insert your fingernail into the notch on the bottom of the battery cover and pull the battery cover upwards.

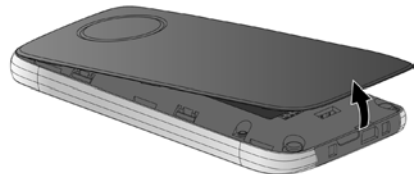

Getting started

Charging the battery

The battery is supplied with a partial charge. Please charge it completely before use.

- ▶ Charge the handset in the charger cradle for **5 hours**.



Please note

- ◆ The handset must only be placed in the designated charger cradle.
- ◆ The battery is also charged if the handset is connected via a USB connection to a PC with a power supply of 500 mA
- ◆ The battery may heat up during charging. This is not dangerous.
- ◆ After a time, the charge capacity of the battery will decrease for technical reasons.

Registering the handset

Please note

The best way to achieve all of the features of the Gigaset SL910H is to register the device to the corresponding base of the Gigaset SL910 or Gigaset SL910A.

If you use the Gigaset SL910H on a different base, features such as the answering machine or call lists are not available.

When your handset has sufficient charge the registration process starts. The registration screen is displayed.

Changing the display language:

- ▶ Menu key ▶ Menu page **Settings**
 - ▶ [**Language + Location**].
- ▶ Touch next to **Display Language**.
- ▶ Next to the desired language, touch
- (= selected). ▶ Confirm with . ▶ Back with .

Registering the handset:

On the base:

- ▶ Press and hold the registration/paging key (min. 3 seconds).

On the handset within a minute:

- ▶ Touch **Register**.

Or, if the handset is already registered to a base:

- ▶ Menu key ▶ Menu page **Settings**
 - ▶ [**Handsets + Base**].
- ▶ Touch **Register**.

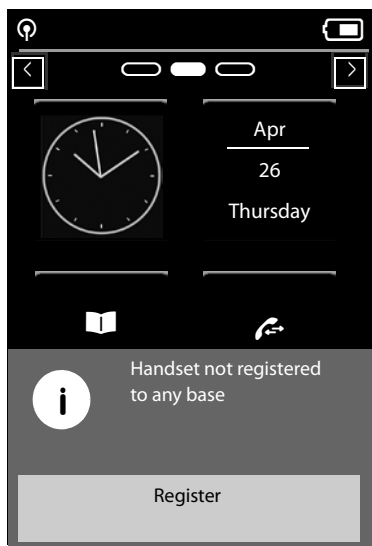

The message "Searching for a base which is in registration mode" appears in the display.

This creates a connection to the base, but it may take some time.

- ▶ If necessary, enter the system PIN of the base (default: **0000**). ▶ Confirm PIN with .

The display shows **Handset is registering**.

After **successful registration**, the " **Handset registered**" message appears. This will start the installation wizard. If applicable, the values set on the base for the date, time, country, country code and local area code are displayed.

The installation wizard is described in the user guide for the base.

Exception:

The handset is registered to a base for a Gigaset SL910/SL910A from an earlier series.

After **successful registration**, the following message is shown in the display.

- ▶ Connect the base to the Internet (see user guide for the base).
- ▶ On the handset, touch **Update Firmware**.

The firmware update can take up to six minutes, depending on the quality of your DSL connection.

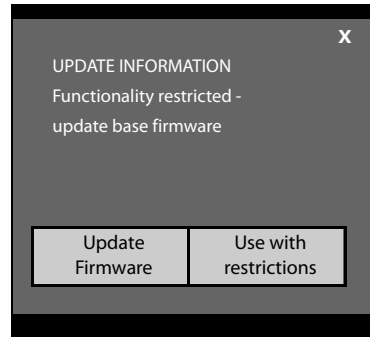

Caution

If you select the **Use with restrictions** option, important functions on your phone will not be available. If you want to complete the firmware update at a later date, you must first reset the base; this action will reset all the base settings and all handsets will be de-registered.

To reset the base: ▶ Remove the power cable from the base ▶ Press and hold the registration/paging key on the base and at the same time reconnect the power cable to the base
▶ Press and hold the registration/paging key until it begins to flash (approx. 10 seconds).

Once the handset has been registered again successfully, the message above is displayed again.



Display pages

Idle display

The idle display comprises three pages:

- ◆ The dial page (see below)
- ◆ The configurable page (→ page 9)
- ◆ The messages page (→ page 10)



Switch between the menu pages:

- ◆ Drag your finger horizontally across the display or
- ◆ In the navigation area, touch  or .

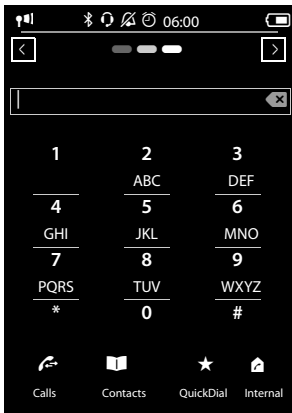
Dial page



Number field

Displays the numbers entered.
 Touch  **briefly**: delete the last number entered
 Press and **hold** : delete all numbers



Keypad



Numerical keypad for entering phone numbers. When you touch a number, it is displayed in the number field.

Options bar (→ page 15)

To dial from call lists, Contacts and speed dial list, as well as internal calls.

Configuring the keyboard/keypad individually



You can change the appearance and behaviour of the keypad shown in the display according to your needs. The settings do not correspond to the handset keys (  .

- ▶ Menu key  ▶ Menu page **Settings** ▶ [ **Display and Keypad**] ▶ Scroll to **Keypad**.

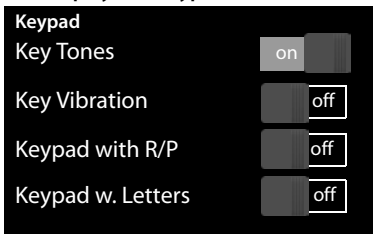
[ **Display and Keypad**] submenu:



You can configure the following:

- ◆ **Key Tones:** Every time you touch a digit, a confirmation tone is audible.
- ◆ **Key Vibration:** Every time you touch a digit on the keypad, the handset vibrates.
- ◆ **Keypad with R/P:** To insert
 - a line interruption (flash, R): **Press and hold** ().
 - a dialling pause (P): **Press and hold** (.
- ◆ **Keypad w. Letters:** For dialling with letters — sometimes used for entering service numbers, for example.
 - ▶ You can use the switch on the right to activate or deactivate the relevant function directly. Change (activate/deactivate) switching: **Briefly** touch the switch.

Configurable (personal) page

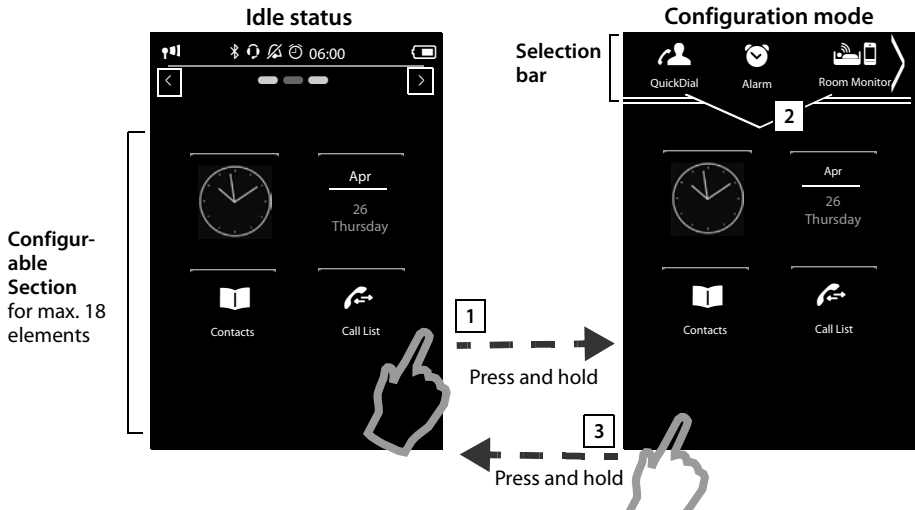

You can **customise the configurable page** to suit your needs. Bring together the important applications and numbers, which you can start up or call directly from idle status with a single touch. By default, the date and time are displayed and quick access to call lists and contacts is possible.



1 Starting the configuration process

- ▶ Switch to the configurable page.
- ▶ Press and **hold** (approx. 2 seconds) any position on the configurable area on the display.

2 Compile application/function

A pick list with the available functions/applications is displayed at the top edge of the display. The  (arrow) icon to the right of the pick list shows that you can move the pick list horizontally to display additional selection options. To do this, place a finger on the pick list and move it in the opposite direction to the  arrow. Additional functions are displayed.

- ▶ **Insert application/function:** Drag the function/application using drag&drop from the selection list into the configurable area.

Please note

With the exception of QuickDial, each function can exist in the configurable area only once. You can collate a maximum of 18 functions, applications or QuickDials.

- ▶ **Remove application/function:** Drag the icon for the application/function back to the selection list using drag&drop.

Please note

A QuickDial is deleted. The related entry in Contacts remains unchanged. The settings for all other functions (e.g., wake-up time) remain unchanged.

Display pages

3 Completing the configuration process

- ▶ Press and hold any position on the configurable area on the display, or
- ▶ Press  briefly.

The settings are saved.

You can now start/select your desired applications/telephone numbers by briefly touching the corresponding icon.

Selectable applications and functions

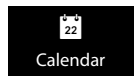

Date display
Open calendar (→ page 39)



Time display
Set time

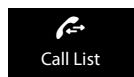

Open call lists (→ page 38)



Set baby phone call
(→ page 41)



Set alarm clock (→ page 40)







Open Contacts (→ page 33)



Speed dial (→ page 37):
Dialling a number

Messages page

You can use the messages page to access the following message lists:

- ◆  Answering machine list (dependent on base)
- ◆  Network mailbox, if your network provider supports this function and the number of the network mailbox is stored in your telephone
- ◆  Incoming message list (dependent on base)
- ◆  Missed calls list (→ Calls list (dependent on base), page 38)
- ◆  Missed appointments list (→ page 40)

Messages page (example)

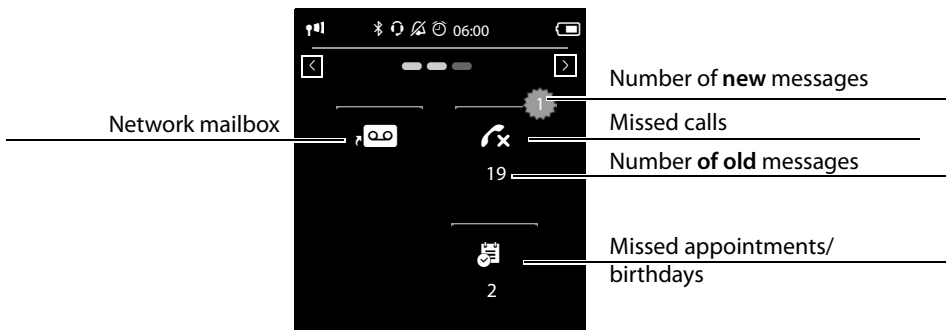

The list of missed calls is always displayed. The icon for the network mailbox is displayed, provided the number is stored in the telephone. The other lists are only displayed if they contain messages.

- ▶ Touch an icon to open the corresponding list.

Exception: If you touch the icon for the **network mailbox**, your telephone will dial the number for the network mailbox (→ page 27). No list will open on the display.

Message pop-up

An advisory tone sounds as soon as a **new entry** arrives in a list. If activated (see the base user guide) the message LED on the left next to the earpiece also flashes and the message pop-up is displayed. The pop-up may partly conceal the dial page and the configurable page. New messages are displayed on the message page as described above.

The number of new messages in each list is displayed beneath the icons.

- ▶ **Close the pop-up:** Touch **X** (top right).
- ▶ **Open the list:** Touch the corresponding list icon.

If there are more new messages in other lists, the display will show the message page (but not the pop-up) when you return to the idle display.

The messages LED flashes (if activated, see base user guide) until you have opened all new messages.

Messages pop-up (example):

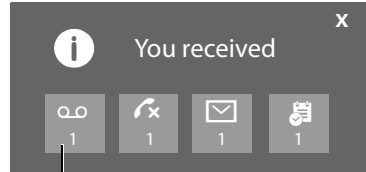

Answering machine (depending on the base) and/or network mailbox

List entry (depending on the base)

The following information is displayed in the list entries:

- ◆ The list type (in the header)
- ◆ Icon for the type of entry.
Call list: (Missed), (Accepted), (Outgoing) The icon is red for new (unread) entries.
- ◆ Caller's number. If the caller's number is stored in Contacts, the caller's name and number type (**Home, Office, Mobile**) is displayed instead. For missed calls, the number of calls from this number is also shown in square brackets.
- ◆ Date and time of call (if set).

You have the following options:

- ▶ **Call back a caller:** Briefly touch the list entry.
- ▶ **Open the detail view:** Next to the entry, touch

The display shows all the available information.

In the detail view, you can delete the entry or add the number of the entry to Contacts (→ page 36).

Call list (example):

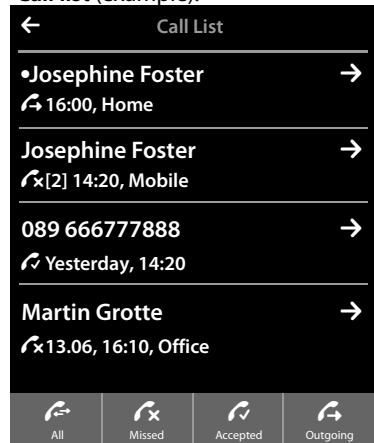



Display pages

Please note

If you press the  key after you have opened a list, the number for the entry marked by a green dot will be dialled immediately.

Deleting lists

You can delete the entire contents of the individual lists:

- ▶ Menu key  Menu page **Settings** ▶ [ **System**]
 - ▶ (Scroll down if necessary) **Clean-up List**
- ▶ Touch  next to the list to be deleted ▶ Confirm with **Yes**.



Status bar and status page

The top line in the idle display is called the status bar. It shows the phone's current settings and operating state (meaning of the icons, → page 45).



Status page

You can use the status page to change the settings of the adjacent components.

- ▶ Briefly touch the status bar to open the status page.
- ▶ Briefly touch the switch next to a component to activate/deactivate it ( = activated).
- ▶ If you touch a list entry, e.g., **Alarm**, a page (the submenu) will open where you can adjust the component's settings.
- ▶ Touch the **Show Service Info** button to display the service information for your handset. You may need the service information when you contact our hotline.
- ▶ Press  or touch  in the top display line to return to the idle display.



Please note

If multiple handsets are registered, the internal number of the handset is displayed in the display status bar (e.g., INT 1)

Menu pages (dependent on base) *

Menu page "Applications"

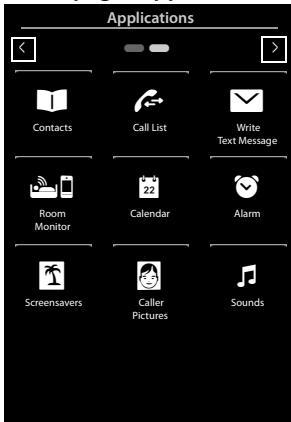

Menu page "Settings"

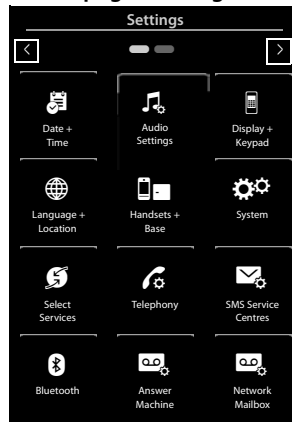



Please note

The applications/settings shown here apply to operation with a Gigaset SL910/SL910A base. When operating with another base, not all applications/settings may be available.

Switching from an idle display to the Applications menu page:

- ▶ Briefly press the  menu key

Switch between the menu pages:

- ◆ Drag your finger horizontally across the display or
- ◆ In the navigation area, touch  or .



Returning to the idle display from anywhere in the menu:

- ▶ Press the  key **briefly**.

***Please note:** Applications/settings that are currently unavailable (e.g., because the handset is outside the range of the base) will not be displayed.

Using the telephone

Switching the handset on/off

- ▶ **To switch off:** In idle status, **press and hold** the end call key .
 - ▶ **To switch on:**
 - Press and **hold** the end call key .
- Or:
- Place the handset in the charger cradle. It will switch on after approximately 35 seconds.

Returning to idle status

- ▶ **Briefly** press end call key .
- Or:
- ▶ If you do not press any key and do not touch the display, the display **automatically** reverts to idle status after approximately three minutes.

Keypad and display lock

The keypad and display lock prevents the phone being operated unintentionally. If you touch the display when the lock is activated, nothing happens. A corresponding message will appear if you press a key.

Activating/deactivating the keypad and display lock

When the handset is in idle status:

- ▶ Press and **hold** the  menu key to activate or deactivate the lock.

If a call is signalled on the handset, the keypad/display lock automatically deactivates and you can accept the call. The key and display lock activates again once the call has finished.

Please note

When the keypad lock is active, you cannot call emergency numbers.

Automatic display lock

During a call, the display is automatically locked with the aid of a proximity sensor if you hold the handset to your ear (display backlight disappears). This lock is deactivated again when you remove the handset from your ear.

The sensor is located on the right next to the earpiece (→ [page 1](#)). If you cover it accidentally with your finger during a call, the display will also be locked.

Operating the touchscreen

You operate the handset mainly via the display.

Icons, list entries, switches and selection areas shown on the display are sensitive areas. You can set up and activate functions, enter or dial phone numbers and navigate between the various display screens (pages) by touching these areas and dragging them across the display.

Selecting functions/list entries

Touch a list entry or the corresponding icon to select the list item (Contacts, submenu, call lists) or to activate/deactivate a function.

Scrolling in lists and menus (scrolling vertically)

- ▶ Drag the display in a vertical direction.

If there are more list entries than can be displayed all at once, a drop shadow at the bottom or top edge of the display indicates the direction in which you have to scroll to view more of the list.

As soon as you scroll in a list, a scroll bar appears on the right side of the display. This shows the size and position of the visible section of the list.



Scrolling through lists is not continuous, i.e., you have to scroll back to return to the top from the end of the list.

Options, option slider

Many displays have an **options bar** at the bottom. This displays all the actions that you can apply in the current context (icons used, → page 44). There are single-row (e.g., in Contacts) and double-row option sliders (e.g., during an external call).

- ▶ Touch an option to execute the corresponding action.

If there are more options available than can be displayed in an options bar at the same time, these additional options are provided as follows:

- ◆ With a one-line options bar, the arrow on the right  and/or left  next to the options (see image) indicates that further options are available.
 - ▶ Touch the option slider and drag it in the direction of the arrow in order to move the additional options into the display (scroll horizontally).

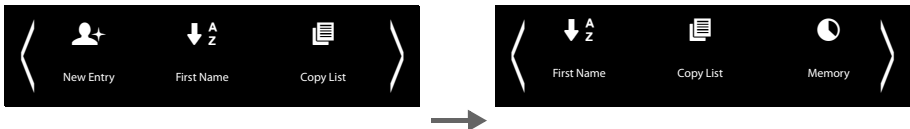

- ◆ With a two-row option slider, the icon  below the option slider indicates that further options are available.

Using the telephone

- ▶ Touch  to display a further option slider that conceals the original option slider.

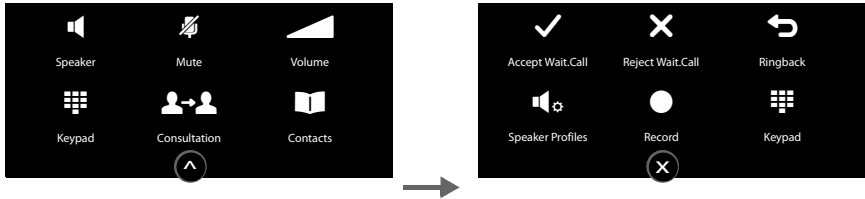

- ▶ Touch  to hide the additional options again.

Changing the settings

Touch an icon on one of the menu pages to open the corresponding application/function. The display shows the configurable parameters and user interface elements as well as their current settings (orange in the display).

Examples:

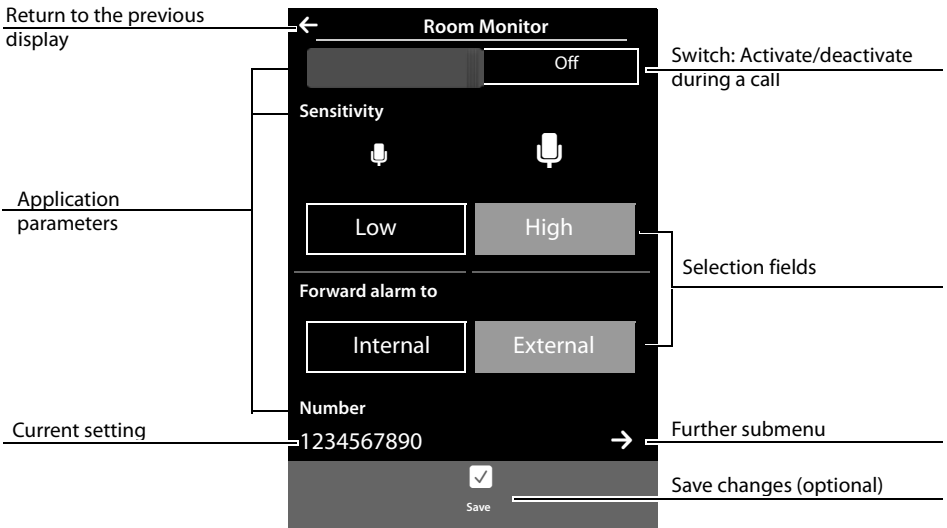

Switch: Activating/deactivating functions

- ▶ **Briefly** touch the switch to activate/deactivate functions such as baby-phone call or.

The function is activated/deactivated if the orange-coloured area (**On / on**) is visible.



Selection fields

If two or three alternative settings are available for one parameter, these alternatives are displayed in the form of selection fields. The current setting appears in orange.

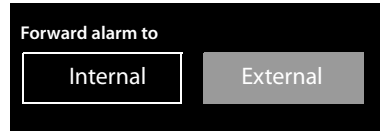

- ▶ To change it, briefly touch the selection field you require.

Opening the submenu to set a parameter

The icon indicates that another submenu is available.

- ▶ Briefly touch to open this submenu.

Return to the previous display

- ▶ You go back to the previous display (step by step) by touching (in the top left of the display).

Entering numbers and text

Touch a character on the display to enlarge it. Keep your finger on the display until you see the desired character enlarged. As soon as you remove your finger from the display, the character is copied to the text field in which the cursor is blinking.

When numerous number and/or text fields are displayed (e.g., first name and surname in a Contacts entry), the first field is automatically activated. You need to touch any subsequent fields to activate them. A field is activated when the flashing cursor appears in the field.

Correcting incorrect entries

Briefly touch : The last character you entered is deleted.

Press and hold : The entire content of the number or text field is deleted.

Entering text

- ▶ Touch (Shift): Switch between lower and upper case.
 - Upper case is only activated for the next character.
 - In Contacts, the first letter and each letter following a space is automatically in upper case.
- ▶ Touch : Enter a digit/a special character.
 - ▶ Touch **More...** to display additional special characters, and touch **Back** to return to the previous display
 - ▶ Touch to return to entering normal characters.
- ▶ You enter special characters (diacritical characters, e.g., umlauts) by pressing and **holding** the corresponding initial letter and selecting the required character from the list displayed.

Latin (default) character set:

a c e i

l n o s u

y z

Greek character set:

α ε η ι ο σ υ ω

Using the telephone

Cyrillic character set:

е э ё € и ъ ї г г' ь ь'

Due to the larger space requirement of the Cyrillic character set, you can also access the following letters by pressing and **holding** the bold characters shown below. Touch the required character.

ц ѣ х ъ ж э

- ▶ Touch  (if necessary several times): switch character set/keyboard assignment. The options are:
 - Latin (default) character set with the keypad layouts QWERTZ, for Central Europe, QUERTY (American default) and AZERTY, for the French-speaking area
 - Greek character set
 - Cyrillic character set

Making calls

Making an external call

- ▶ Switch to the dial page ▶ Enter the number ▶ **Briefly press** .

Or:

- ▶ In idle mode, press and **hold**  ▶ Enter the number.

You can cancel dialling by pressing .

Dialling with the redial list

- ▶ In idle mode, **briefly press**  to open the redial list.

You have the following options:

- ▶ Press . The number with the green dot is dialled.

Or:

- ▶ Touch an entry in the list. This selects the number displayed in the entry.

Or:

- ▶ Next to an entry, touch  The detail view is opened.

- Contacts entry exists:

All numbers for the Contacts entry are displayed:

- ▶ Press . The preferred number of the Contacts entry which is marked with a green dot (→ page 33) is dialled.

Or:

- ▶ Touch the desired number.

- No Contacts entry exists: Press .

Redial list (example):



Please note

The redial list contains the last twenty numbers dialled with this handset. You can manage them in the same way as the message lists on your telephone:

- ▶ **Open the detail view:** Next to the entry, touch  The display shows all the available information. In the detail view, you can delete the entry or add the number of the entry to Contacts (→ page 36).

Making calls

Dialling from a call list

- ▶ Switch to the message page ▶ Touch .



You have the following options:

- ▶ Press . The number of the entry marked with the green dot is dialled.

Or:

- ▶ **Briefly** touch an entry in the list. This selects the number displayed in the entry.



Or:

- ▶ Next to an entry, touch . The detail view is opened.
 - ▶ Press . This selects the number displayed in the entry.

Or:

- ▶ Contacts entry exists: Touch . All numbers for the Contacts entry are displayed. Touch the desired number.

Dialling with Contacts

- ▶ **Open Contacts:** On the dial page, touch  [ **Contacts**]. The list of Contacts entries is displayed.
- ▶ Scroll through the list to the desired entry.

You have the following options:

- ▶ Press . The preferred number (→ [page 33](#)) of the entry marked with the green dot is dialled.

Or:

- ▶ Touch the name in the entry. The preferred number of the entry is dialled.

Or:

- ▶ Touch  next to the entry and then touch the required number in the detail view.

Accepting a call

You have the following options

- ▶ Press .
- ▶ If **Auto Answer** is activated (→ [page 24](#)), remove the handset from the charging cradle.
- ▶ **Accept a call on a Bluetooth headset:** → [page 32](#)
- ▶ **Accept a call on a wire-bound headset:** Press the talk key (push-to-talk key) on the headset. The headset must be connected to the handset (→ [page 1](#)).

Accepting/rejecting call waiting

If you receive a call during a conversation, you will hear a call waiting signal and see a corresponding message on the display. For further information, please refer to your base user guide.

Call list (example)

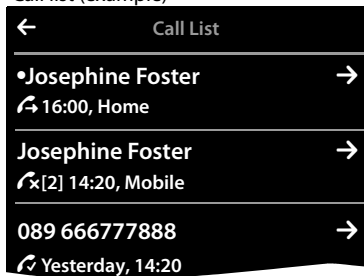

Detail view of an entry (example)

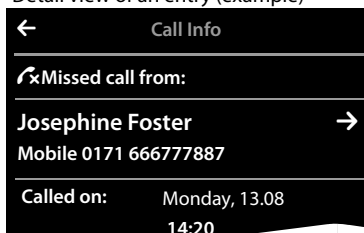

Call display

For calling line identification

The caller's phone number is displayed. The display will also show the number type and the name of the caller if the caller's number is stored in your Contacts. If you have assigned a picture to the caller's number (→ page 33), it also appears on the display.

No calling line identification

Instead of name and number, the following is displayed:

- ◆ **External:** No number is transferred.
- ◆ **Withheld:** Caller has withheld calling line identification.
- ◆ **Unavailable:** Caller has not requested calling line identification.

For CNIP (Calling Name Identification Presentation)

In **addition** to the number, the registered name (and location) of the caller is displayed. The name of the Contacts entry appears on the display instead of the number if you have saved the number in the contacts.

Notes on phone number display (CLIP)

(CLIP = Calling Line Identification Presentation)

The default setting on your phone is set to display the caller's number, → page 51 or → www.gigaset.com/service

Speaker



If you are going to let someone listen in, you should tell the other party that this is happening.

Activating handsfree mode while dialling

- ▶ Enter the number, press  twice.

Switching between earpiece and handsfree mode

During a call, when establishing the connection:



- ▶ Press  or touch [ Speaker].

Place the handset in the charging cradle during a call:

- ▶ Press and hold the  key while placing the handset in the charging cradle and hold for a further 2 seconds.

Changing the earpiece, handsfree and headset volume

You adjust the volume for the current mode (handsfree, earpiece, headset) during a call:

- ▶ Touch [ **Volume**] ▶ Adjust the volume with \oplus / \ominus .
- ▶ If a headset is connected: To adjust the **Microphone Sensitivity** touch \oplus / \ominus in the second row several times if necessary.
- ▶ Touch  at the bottom of the display to save the settings.
Or: The setting is saved automatically after approximately 2 seconds.

Activating/deactivating the microphone (muting)

If you turn the microphone off during a call, your caller can no longer hear you.

- ▶ To activate/deactivate the microphone, touch [ **Mute**].

Deactivating the ring tone/silent alert for the current call

A call is signalled on the handset:

- ▶ Touch [ **Silence**].

Security check

The handset detects unsecured connections to the base, which third parties could use to listen in.

When establishing an external call or during an external call:

- ▶ Press and **hold** any position on the status bar.

If **Secure connection to base** is displayed, the connection is secure.

If **No secure connection to base** is displayed, you should end the call.

Changing phone settings

The handset comes with default settings but you can change the settings to suit your individual requirements.

You can change settings either during a call or in idle status via the **Settings** menu page.

Changing the display language

- ▶ Menu key ▶ Menu page **Settings** ▶ [**Language + Location**].
- ▶ Next to **Display Language** touch ▶ Next to the selected language, touch (= selected) ▶ Confirm with ▶ Return with .

Setting the country and your own area code

- ▶ Menu key ▶ Menu page **Settings** ▶ [**Language + Location**].

Setting the display

Setting the screensaver/Slideshow

You can define a screensaver for the display's idle status. The options are **Analogue Clock/Digital Clock/Slideshow**/pictures. You can load pictures onto your handset using the **Gigaset QuickSync** (→ page 43) software.

To show the idle display again, **briefly** press or touch the display.

- ▶ Menu key ▶ Menu page **Settings** ▶ [**Display + Keypad**].
- ▶ Use the switch to activate/deactivate the screensaver.
 - ▶ Next to **Selection** touch ▶ Drag your finger horizontally across the display to scroll through the selection ▶ Touch [**Select**] to select the current display, or touch to go back without saving.

[**Display + Keypad**] submenu

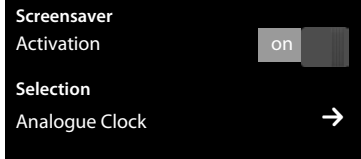

Setting the display backlight

The display backlight switches itself on as soon as the handset is moved or you press a key.

You can specify the period of time in idle status after which the display backlight is switched off. If no period is set, the display is permanently dimmed.

- ▶ Menu key ▶ Menu page **Settings** ▶ [**Display + Keypad**].
- ▶ Using the switch, activate/deactivate the display backlight in the charger cradle or outside the charger cradle.
- ▶ Next to **Timeout** touch ▶ Select the off time. Save and go back with .

[**Display + Keypad**] submenu

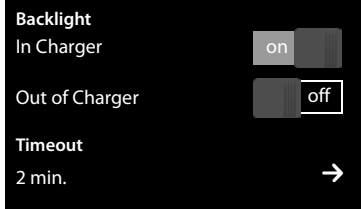

Please note

The handset's standby time can be significantly reduced if the display backlight is activated.

Activating/deactivating auto answer

When auto answer is activated the handset accepts an incoming call as soon as you take it from the charger cradle.

- ▶ Menu key **O** ▶ Menu page **Settings** ▶ [**☎** **Telephony**].
- ▶ Activate/deactivate the function with the switch next to **Auto Answer**.

The connection is terminated as soon as you return the handset to the charger cradle, regardless of the **Auto Answer** setting. Exception: you press **↵** when returning the handset to the charger cradle and hold it for two more seconds when it is in place.

Setting a speaker profile

You can set various speaker profiles to optimally adapt your phone to your environment. Try them out to see which profile you prefer.

The default is **Profile 1**.

During an external call in speaker mode:

- ▶ In the option slider, touch **▲** and then [**🔊** **Speaker Profiles**] ▶ Select a profile. The setting is adjusted immediately.

Setting ring tones

Setting volume, melody

- ▶ Menu key **O** ▶ Menu page **Settings** ▶ [**🔊** **Audio Settings**] ▶ **Ringtones**

Ring tone volume for all calls

- ▶ Touch **⊕** / **⊖**, several times if necessary, to adjust the volume.

Or

- ▶ Activate/deactivate the crescendo ring tone (increasing volume) with the switch next to **Crescendo**.

The activated crescendo only applies to ring tone volume. It does not affect how a melody is played back.

Setting the ring tone for external/internal calls

- ▶ Next to **Int. Calls** / **Ext. Calls** touch **➔** ▶ Select a ringer melody ▶ Save and return with **⬅**.

You can load additional ring tones onto your handset using the **Gigaset QuickSync** (➔ page 43) software.

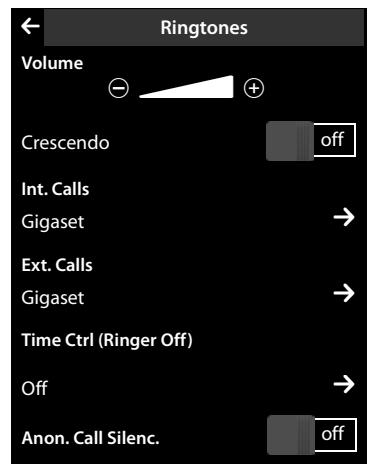

Activating/deactivating silent alert.

- ▶ Menu key **O** ▶ Menu page **Settings** ▶ [**🔊** **Audio Settings**] ▶ Activate/deactivate silent alert using the switch next to **Silent Alert**.

An activated vibration alert signals each internal/external call, appointment, birthday and each wake-up call, without differentiating between them.

The silent alert is deactivated as long as the handset is in the charger cradle or is connected to your PC via USB.

Permanently activating/deactivating the ring tone

You can permanently activate/deactivate the ring tone.

- ▶ Open the status page ▶ Activate/deactivate the ring tone with the switch next to **Do not disturb**. This setting has no effect on the silent alert.

The **🔇** icon in the status bar indicates that the ring tone is deactivated.

Activating/deactivating advisory tones

Your handset uses advisory tones to tell you about different activities and statuses. These advisory tones can be activated/deactivated independently of each other.

- ▶ Menu key **O** ▶ Menu page **Settings** ▶ [**🔊** **Audio Settings**].

You can activate/deactivate the following functions with the switches to the right:

- **Confirmations:**
Confirmation/error tone after input; advisory tone on receipt of a new message.
- **Battery Warning:**
Warning tone when the battery charge is less than 10% (every 60 seconds). The battery warning tone does not sound when the baby phone call is activated.

In the [**🔊** **Audio Settings**] submenu:

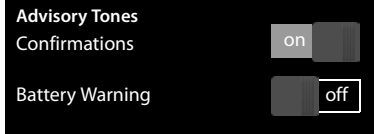

Protection from undesired calls

Setting time control for external calls

You can specify a time period when you do not want the telephone to ring.

- ▶ Menu key **O** ▶ Menu page **Settings** ▶ [**🔊** **Audio Settings**] ▶ **Ringtones**
- ▶ Next to **Time Ctrl (Ringer Off)** touch **👉** ▶ **Touch Switch off ringtones from** ▶ Set the start of the time period ▶ Save and return with **👈** ▶ Repeat the process for **until**, set the end of this time period ▶ Activate/deactivate the time control with the switch next to **Activation** ▶ Go back with **👈**.

Please note

During this period, you will continue to receive calls from numbers to which you have assigned a personalised ring tone in Contacts (VIP).

Restoring handset to default settings



You can reset individual changes to the handset.

The following are **not** affected by the reset:

- ◆ Date and time
- ◆ Registration of handsets to the base or registration of one handset to multiple bases, and the current base selection,
- ◆ Entries in the calendar and in Contacts
- ◆ Redial list and the content of the media pool
- ◆ Stored external and internal destination numbers for the baby phone call (**Forward alarm to** is reset to **External**)
- ◆ Destination number for call divert.

Resetting the handset (**Handset Reset**) deletes your settings for the configurable page (→ page 9) and your audio and display settings.

Resetting the handset

- ▶ Menu key  ▶ Menu page **Settings** ▶ [ **System**].
- ▶ Touch **Handset Reset** .



ECO DECT indicates low energy consumption and reduced transmission power.

Reducing energy consumption

Your telephone has a power-saving adapter plug and uses less power.

Reducing radiation (dependent on base)

The radiation can only be reduced if your base supports this function.

The telephone's transmission power is **automatically** reduced depending on the distance to the base.





You can reduce the radiation from the handset and the base even more by doing the following:

- ◆ Deactivate **Max. Range**
- ◆ Activate **No Radiation**.

For further details, please refer to your base user guide.

Network mailbox

You can only use the network mailbox if you have **requested** it from your provider and saved the network mailbox number in your phone.

- ▶ Menu key  ▶ Menu page **Settings** ▶ [ **Network Mailbox**].
- ▶ Enter the network mailbox number: Next to **Access Number** touch  ▶ Enter number ▶ Confirm and save with .
- ▶ Activate/deactivate network mailboxes (if your network provider supports this function): Touch **On/Off**
 - ▶ After the confirmation tone from the telephone network, press .

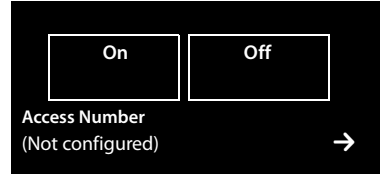

After saving the phone number, the following icon is displayed on the message page:



There are new messages
(if your network provider supports this function)

Playing back network mailbox messages

- ▶ Switch to the message page ▶ Touch the  icon.

Your network mailbox is called directly. The handsfree mode is activated on the handset. You can listen to the messages.

Multiple handsets





Using the handset on multiple bases

Your handset can be registered on up to four bases.

The active base is the last one your handset was registered with. The other bases are stored in the list of available bases.





You can change the allocation to a base **manually at any time**.

Alternatively, you can set the handset so that it selects the base with the best reception (**Best Base**) as soon as the connection to the current base is lost.

- ▶ Menu key  ▶ Menu page **Settings** ▶ [ **Handsets + Base**].
- ▶ Touch **Connected to Base**  ▶ Select the desired base or select **Best Base** ( = selected).

Changing the handset name

When you register multiple handsets the names **INT 1**, **INT 2** and so on are automatically assigned. To change the name:

- ▶ In the **Settings** menu, touch [ **Handsets + Base**].
- ▶ Touch **Registered Handsets**  ▶ Select handset.
- ▶ Delete the old name with  and enter the new name (max. 10 alphanumeric characters)
 - ▶ Confirm with .

Making internal calls

Internal calls to other handsets registered to the same base are free of charge.

- ▶ Switch to the dial page ▶ Touch [ **Internal**] ▶ If necessary, select a handset from the list or touch **All Handsets (group call)**.

After opening the list, press  to initiate a group call to all handsets.

Internal consultation/internal transfer

You are speaking with an **external** participant and want to consult an **internal** participant or transfer the call to him.

- ▶ Touch [ **Consultation**] and then **Internal**.
- ▶ If more than two handsets are registered to the base, select one handset or **All**.

Consulting: You consult the internal participant and return to the external call:

- ▶ Touch [ **End Consultation**].

Transferring the external call: you have two options to transfer the external call:

- ▶ You wait until the participant answers your call and then you hang up.
Press .

or

- ▶ You hang up before the participant answers your call: Press .



If the other participant does not answer your call, cancel the consultation call with [ **End Consultation**].

Establishing a conference call/call swapping

You are engaged in one conversation whilst another one is on hold. Both participants appear in the display.

- ▶ **Call swapping:** On the display, touch the participant with whom you wish to speak.

Or:

- ▶ **Establish a three-way conference call:** Touch [ **Conference**].
- ▶ **End conference call:** Touch [ **End Conference**]. You return to "call swapping" and are again connected to the participant with whom you initiated the conference.

Each of the callers can end their participation in the conference call by pressing the end call key and terminating the call.

Bluetooth devices

You can register up to five data devices (PC, PDA, mobile phones) and one Bluetooth headset. You must activate Bluetooth on the handset, ensure the devices are visible if necessary and then register the handset.

You can exchange entries in Contacts using the data devices and load ring tones and pictures to the handset using the **Gigaset QuickSync** software (→ page 43).

Please note

- ◆ A headset must have the **headset** or **handsfree profile**. The handsfree profile is preferred.
- ◆ Establishing a connection to a headset can take up to 5 seconds.

Activating/deactivating Bluetooth mode

You can activate/deactivate Bluetooth mode using the status page (→ page 12) or as follows:

- ▶ Menu key **O** ▶ Menu page **Settings** ▶ [**Bluetooth**] ▶ Activate/deactivate Bluetooth using the switch next to **Activation**.

If Bluetooth is activated:

- ◆ **Bluetooth** is displayed in the status bar (→ page 44).
- ◆ The handset can communicate with all devices in the **Known Devices** list.
- ◆ The handset is visible to Bluetooth devices within its range.
- ◆ If the known devices include a headset, the handset establishes a connection to this headset.
- ◆ The handset searches for Bluetooth devices within range.

Finding and registering (trusting) Bluetooth devices

The distance between the handset and the activated Bluetooth device should be a maximum of 10 m.

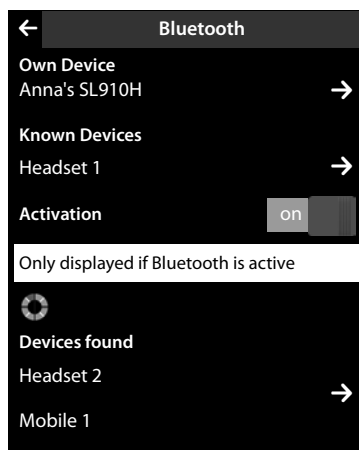



Please note

- ◆ If you register a headset, any previously registered headset is overwritten.
- ◆ If a headset is already registered to another device, please **deactivate** this connection before starting the registration process.

Starting the search

The search starts as soon as the Bluetooth page is opened and Bluetooth has been activated. The handset searches for Bluetooth devices within its range. Located devices are added to the **Devices found** list.

Pairing the device — adding the device to the known devices list

- ▶ Next to the list **Devices found** touch  (see image above).
- ▶ In the **Devices found** list, select device ▶ Touch [ **Trust Device**] ▶ If necessary, enter the PIN of the device to be registered ▶ Confirm with .

PIN for a **data device**: Enter any PIN on the handset and then also on the data device (0 – 16 digits).

PIN for a **headset**: **0000** is generally preset. Therefore, you only need to enter the PIN in exceptional cases.

If **Known Devices** already contains six entries, the last entry is overwritten.

Exception: a headset only overwrites a headset.

Ending the search

- ▶ Touch  to close the submenu **Bluetooth**, or deactivate Bluetooth.



Editing the list of paired (trusted) devices

Opening the list

- ▶ In the submenu **Bluetooth** next to **Known Devices** touch .

A  next to the device name in the list indicates a headset and  indicates a data device.

De-registering the device

- ▶ Open **Known Devices** list ▶ Touch [ **Delete**] ▶ Select one or more devices – next to the relevant devices, touch  ▶ Touch [ **Delete**] ▶ Touch **Yes**.

Changing the name of a device

- ▶ Open the **Known Devices** list ▶ Select device ▶ If necessary, delete the previous name with  ▶ Enter name (max. 16 characters) ▶ Confirm with .

Rejecting/accepting an unregistered Bluetooth device



If an unknown Bluetooth device tries to establish a connection, you will be asked to enter the device's PIN (bonding).

- ▶ **Reject**: Touch  or press .

Or:

- ▶ **Accept**: Enter the device PIN ▶ Confirm with .
 - ▶ Touch **Yes**: Add to the **Known Devices** list, or
 - ▶ Touch **No**: Temporarily use device.

Changing the handset's Bluetooth name

- ▶ In the **Bluetooth** submenu, touch **Own Device Own Device**. Activates Bluetooth if it is deactivated ▶ If necessary, delete the previous name with  ▶ Enter the new name
- ▶ Confirm with .

Continuing a handset call on the Bluetooth headset

Prerequisite: Bluetooth is activated; the Bluetooth headset and the handset are connected.

- ▶ Press the talk key on the headset.

It may take up to 5 seconds to establish a connection to the headset.

Use [ **Volume**] **Headset Volume/Microphone Sensitivity** to adjust.

For further details about your headset, see the accompanying user guide.

Please note

If a wire-bound headset and a Bluetooth headset are connected at the same time, you are unable to use the wire-bound headset.

Accepting a call on a Bluetooth headset

Prerequisite: Bluetooth is activated; the Bluetooth headset and the handset are connected.

Only press the talk key on the headset when the headset rings.

For further details about your headset, see the accompanying user guide.

Contacts (address book)

You can save up to eight numbers, together with the first name and surname, birthdays/anniversaries with signalling, VIP ring tone and caller picture in each **Contacts entry**. You can synchronise Contacts with the Outlook contacts in your PC address book and upload ring tones and pictures to your handset (→ page 43).

You can create a Contacts list (with up to 500 entries) individually for each of your handsets. You can also send lists/entries to other handsets (→ page 35). You can use your PC and the free Gigaset QuickSync software (→ page 43) to compare the Contacts list with your Google and Outlook contacts (→ page 43).

Please note

To quickly access a number from Contacts, you can place the number on the configurable page in the idle display (→ page 9).

Length of the entries

8 numbers: Max. 32 digits each
 First name and surname: Max. 16 characters each

Managing entries in Contacts

Opening Contacts

- ▶ Menu key ▶ [Contacts] or
- ▶ Touch [Contacts] on the dial page or during a call.

Creating a new entry

- ▶ Open Contacts ▶ Touch [New Entry].
- ▶ Enter the components of each entry via the individual fields (name, number, VIP ring tone, birthday). To do this, next to the relevant component, touch ▶ If available, confirm a component with or [Select].
To create an entry, you must enter at least one number.
- ▶ **Add caller picture:** Touch . Select picture with / and then touch [Select].
- ▶ **Define a preferred number for an entry:** The preferred number is automatically selected if you touch the entry in Contacts or press in the detail view. It is highlighted (in green).
To change the setting: Press next to the desired number.

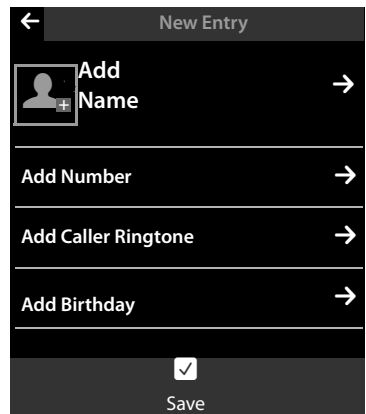

Saving a Contacts entry











- ▶ Touch [Save].

Viewing an entry (detail view)

- ▶ Open Contacts ▶ Next to the desired entry, touch 

All the information relating to the entry is displayed.



Editing entries

- ▶ Touch [ **Edit**] in the detail view.
 - Change/delete first name, surname, or number: ▶ Touch  ▶ If necessary, touch the corresponding field ▶ Enter/change name/number ▶ Confirm with .
 - Add number: Touch  next to **Add Number** ▶ Enter the number and confirm with .
 - Assign a VIP ring tone or delete a birthday: ▶ Next to **Add Caller Ringtone** / **Add Birthday** touch  ▶ Touch [ **No Ringtone**] / [ **No Birthday**].
 - Delete caller picture assignment: ▶ Touch the caller picture ▶ Touch [ **No Picture**].
 - Change preferred number: ▶ To activate a different preferred number, touch  next to this number.
- ▶ Touch [ **Save**].

Deleting an entry

- ▶ In the detail view: Touch [ **Delete**] ▶ Confirm with **Yes**.

Delete **all** entries in Contacts:





- ▶ Menu key  ▶ Menu page **Settings** ▶ [ **System**] ▶ (Scroll if necessary)
 - ▶ Next to **Clean-up List** touch  ▶ Next to **Contacts** touch  ▶ Confirm with **Yes**.

Displaying the number of entries that are still available in Contacts

- ▶ Open Contacts ▶ Touch [ **Memory**].

Defining the order of entries in Contacts

Define whether the entries are to be sorted by first name or surname.

- ▶ Open Contacts ▶ Touch [  **Surname**] or [  **First Name**]

If an entry does not contain a name, the preferred number (number marked with the green dot → [page 33](#)) is copied to the surname field. These entries appear at the beginning of the list, regardless of how the entries are sorted.

The sort order is as follows:

Space | Digits (0–9) | Letters (alphabetical) | Other characters.

Selecting a Contacts entry, navigating in Contacts

If there are more than seven entries in your Contacts list, a scroll bar appears on the right-hand side. You have the following options:

- ◆ Scroll to the name you are searching for.
- ◆ Touch the first letter in the index. The display jumps to the first name that begins with this letter. If necessary, scroll until you reach the desired entry. While you are scrolling, the index is temporarily covered by a scroll bar.

Transferring an entry/Contacts to another handset

Prerequisites:

- ◆ The sending and receiving handsets must both be registered to the same base.
- ◆ The other handset and the base can send and receive Contacts entries.

You can transfer the entire Contacts list, an individual entry or multiple individual entries.

Please note

- ◆ An external call will interrupt the transfer.
- ◆ Caller pictures and sounds are not transferred. For a birthday, only the date is transferred.
- ◆ When transferring an entry between two vCard handsets:
 - If the recipient does not yet have an entry with that name, a new entry is created.
 - If there is already an entry with that name, this entry is expanded with the new numbers. Where there are more than eight numbers in total, a second entry is created with the same name.
- ◆ If the recipient is not a vCard handset: an entry is created and sent for each number.
- ◆ Your handset receives entries from a non-vCard handset: entries with numbers already saved are rejected; otherwise a new entry is created.

Transferring individual entries

- ▶ Open the detail view of the entry (→ [page 34](#)) ▶ Touch [ Copy]
 - ▶ Respond to the prompt with **Internal Handset** ▶ Select the recipient handset.

After a successful transfer:

- ▶ Touch **Yes** if another entry should be sent. Otherwise touch **No**.





Transferring the entire Contacts list

- ▶ Open Contacts (→ [page 33](#)). Touch [ Copy List] ▶ Respond to the prompt with **Internal Handset** ▶ Select the recipient handset.

Cancel transmission

- ▶ Press .

Transferring Contacts as a vCard with Bluetooth

- ▶ Open Contacts (→ page 33).
 - ▶ **Send entire Contacts list:** Touch [ Copy List].
- Or:
 - ▶ **Send entry:** Next to the entry, touch  and then touch [ Copy].
- ▶ In the pop-up that is displayed, touch **BluetoothDevice**. Bluetooth is activated, if necessary.
- ▶ Select recipient:
 - ▶ Select the recipient from the list of known devices (→ page 31). The transfer starts. Or:
 - ▶ Touch [ Search] and select the recipient from the **Devices found** list ▶ Enter the recipient's PIN and touch .



Receiving a vCard with Bluetooth

Prerequisite: the handset is in idle status. Bluetooth is activated.

- ▶ If the sender is in the **Known Devices** (→ page 31) list, receipt occurs automatically.
- ▶ If the sender is not in the **Known Devices** list, enter the sender's device PIN and touch . Following the vCard transfer, state whether the device should be added () to the **Known Devices** list (**Yes**) or not (**No**).

Adding a displayed number to Contacts

You can copy numbers that are displayed in a list (e.g., call list, redial list) , as well as numbers that you have just dialled or entered for dialling, to Contacts.

- ▶ On the dial page or in the detail view of a list entry, touch [ Copy Number] (you may have to scroll in the options bar).
- ◆ **Create new entry:** ▶ Touch [ New Entry]. The number is transferred as the first number of the entry with number type **Home** ▶ Extend the entry if necessary ▶ Touch [ Save].

Or:



- ◆ **Add a number to an existing entry:**
 - ▶ Select entry ▶ Touch the **Add** switch.
 - Number is entered with number type **Home** ▶ If necessary, extend or change the entry
 - ▶ Touch [ Save].

Or:

- ▶ Select entry ▶ Select the number that you want to overwrite ▶ Touch **Yes**
 - ▶ If necessary, extend or change the entry ▶ Touch [ Save].

Copying a number from Contacts

In certain operating situations you can open the Contacts list to copy a number, e.g., when you are dialling (even after you have entered a suffix).

- ▶ Depending on the operating situation, open the Contacts list with [ Contacts] or .
 - ▶ Touch a Contacts entry to copy its preferred number.
- Or:
- ▶ Next to the entry, touch  and then touch the number to be copied.

Configuring QuickDial/QuickDial shortcuts

Prerequisite: There must be at least one number in Contacts.

You can provide numbers from Contacts for the QuickDial (QuickDial) in two ways:

- ◆ Create a symbol on the configurable (own) page for each number.
- ◆ Transfer a number to the QuickDial shortcuts.

Creating a QuickDial icon on the configurable page

- ▶ Switch to the configurable page and start the configuration (page 9).
- ▶ Drag icon  for the QuickDial from the pick list to the page ▶ Select the Contacts entry
 - ▶ The detail view is displayed for an entry with several numbers: select the telephone number.

You can repeat this process several times with different numbers.

One of the icons on the right is created on the configurable page. The number is not entered into the QuickDial shortcuts.

Dial number: ▶ Touch the QuickDial shortcut icon on the configurable page.

Change QuickDial:

- ▶ Change the number in Contacts. The QuickDial on the configurable page changes accordingly.

Or:

- ▶ Delete the QuickDial on the configurable page and create a new QuickDial icon with the new number.

Delete QuickDial

- ▶ In configuration mode, drag the QuickDial icon to be deleted into the pick list. The Contacts entry does not change.

Or:

- ▶ Delete the number in Contacts. The QuickDial icon is automatically removed from the configurable page.

Caller picture assigned:

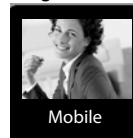

Otherwise:



Calls list (dependent on base)

Transferring the telephone number to the QuickDial shortcuts

You can save up to 7 frequently dialled numbers from Contacts in the QuickDial list so you can access them quickly.

- ▶ Switch to the dial page ▶ Touch [QuickDial] ▶ Touch [New Entry] ▶ Select the Contacts entry ▶ The detail view is displayed for an entry with several numbers: select the telephone number.

Dialling a number:

- ▶ Switch to the dial page ▶ Touch [QuickDial] ▶ Select entry.
 - The number is dialled immediately if the number field on the dial page is empty.
 - If the number field already contains characters, the number behind this character is inserted in the number field.
 - ▶ If necessary, change the number in the number field ▶ Press .

Deleting entries:

- ▶ Touch [Delete] ▶ Touch all the entries to be deleted in sequence and then touch [Delete].

Please note

If you change/delete a number from Contacts, the same number is automatically deleted from the QuickDial list.

Calls list (dependent on base)

Your telephone stores various types of calls:

- ◆ **All:** Full list (**Call List**) of all calls (missed, outgoing, incoming)
- ◆ **Missed:** List of missed (unaccepted) calls
- ◆ **Accepted:** List of accepted calls (
- ◆ **Outgoing:** List of outgoing calls (dialled numbers)
 - ▶ If you open the call list via the messages page or the message pop-up (→ [page 10](#)), the **Missed Calls** is displayed.
 - ▶ The full list of all calls is displayed when you open the call list via:
 - Menu key ▶ [Call List],
 - The option [Calls] on the dial page
 - [Call List] on the configurable page.

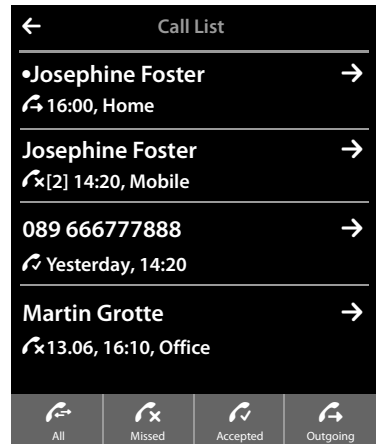

Switching between the lists of the different call types:

- ▶ At the bottom of the page, touch the icon for the desired call type.

Calendar

You can remind yourself of up to **100 appointments**. Birthdays saved in Contacts are transferred to the calendar. The current day is highlighted in grey in the calendar. Days with appointments are marked with a coloured bar. When you select a day, it is highlighted in colour.

Mo	Tu	We	Th	Fr	Sa	Su
01	02	03	04	05	06	07
08	09	10	11	12	13	14
15	16	17	18	19	20	21

Saving appointments to the calendar

Prerequisite: The date and time have already been set.

- ▶ Menu key ▶ [**Calendar**] ▶ Touch / to set the month ▶ Touch the desired day and then touch [**New**].

The following information can be added:

- **Text:** Appointment name (e.g., dentist, cinema with Anna).
 - **Time:** Time (hour and minutes) for the appointment.
 - **Reminder:** You can also set a reminder in advance of the actual appointment. Use the slider to set a time between **15 min.** and **1 week**.
 - **Sound:** Touch / to activate/deactivate the acoustic signal.
- ▶ Touch [**Save**].

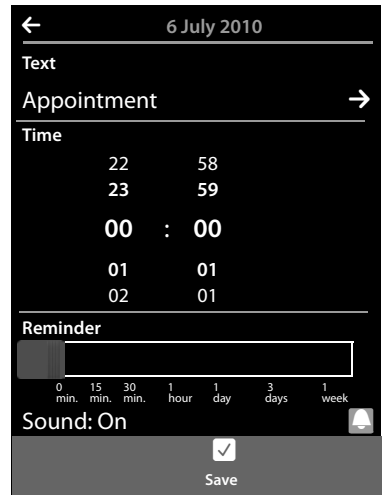

Setting the tones and volumes of the reminder signal

- ▶ Menu key ▶ Menu page **Settings** ▶ [**Audio Settings**] ▶ Next to **Reminder Signal** touch .
- ▶ Set the volume using / or set increasing volume using the switch next to **Crescendo**
- ▶ Next to **Sound** touch ▶ Select a ringer melody ▶ Save and return with .

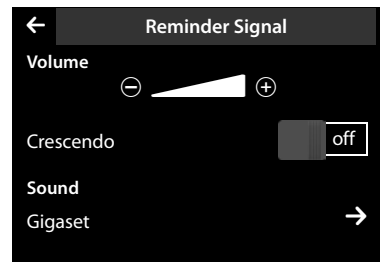

Signalling appointments and birthdays

An appointment/birthday is displayed in idle status and signalled for 60 seconds.

Deactivating the reminder signal :

- ▶ Touch **Off** to acknowledge and end the reminder signal.

When you are on the phone, an appointment/birthday is indicated on the handset with a **single advisory tone**.

If the ring tone is deactivated, the reminder signal does not sound.

Displaying unacknowledged appointments/birthdays

The following appointments and birthdays are saved in the **Reminders / Events** list:

- ◆ You have not acknowledged the reminder for this appointment/birthday.
- ◆ The appointment/birthday was signalled during a phone call.
- ◆ The handset was deactivated at the time of the appointment/birthday.



The last 20 entries are displayed.

The **Reminders / Events** list is displayed on the messages page (→ page 10) with the icon next to it:

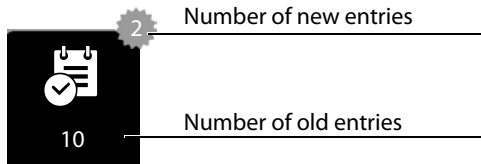
- ▶ **Open list:** Switch to the messages page and touch .



Deleting entries

- ▶ Open list ▶ Touch [ **Delete**] ▶ Touch all the entries to be deleted in sequence and then touch [ **Delete**].

Deleting all appointments from the list:







- ▶ Menu key  ▶ Menu page **Settings** ▶ [ **System**] ▶ **Clean-up List** (scroll if necessary) ▶ Next to **All Past Appointments** touch  ▶ Confirm with **Yes**.

All expired appointments from the calendar and all entries from the **Reminders / Events** list are deleted.

Alarm

Prerequisite: The date and time have already been set.

You can activate/deactivate and set the alarm clock using the status page (→ page 12) or as follows:

- ▶ Menu key  ▶ [ **Alarm**] ▶ Activate/deactivate the alarm clock with the switch at the top of the display.
- ▶ Touch [ **Edit**] to change the settings for the alarm.
- ▶ Set the hour and minutes for the wake-up time.
- ▶ In the following line, touch the weekdays when the alarm clock should sound (orange = selected).
- ▶ Next to **Ringtone** touch  ▶ Select the ringer melody for the wake-up call ▶ Go back with .
- ▶ Touch [ **Save**].

A wake-up call is signalled in the display and with the selected ring tone for a maximum of 180 seconds. During a call, the wake-up call is only signalled by a short tone.

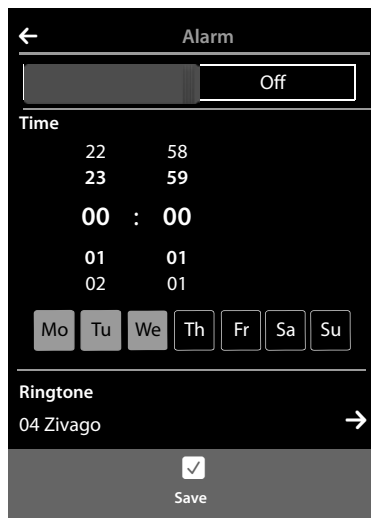

Please note

The wake-up call volume increases over time (fixed setting).

Deactivating the wake-up call/repeating after a pause (snooze mode)

Prerequisite: A wake-up call sounds on the handset.

▶ **Deactivate:** Touch **Off**.

Or:

▶ **Snooze mode:** Touch **Snooze**. The wake-up call is repeated after 5 minutes. After the second repetition the wake-up call is deactivated for at least 24 hours.

Baby phone call

When the baby phone is switched on, the stored (internal or external) destination number is called as soon as a defined noise level is exceeded in the vicinity of the handset.

A baby phone call to an external destination number is cancelled after approximately 90 seconds (= time for connection to be set up + duration of the connection). The baby phone call to an internal number is cancelled after approx. 3 minutes (depending on the base). During a baby phone call, the accept call and menu keys of the baby phone call handset are locked and the loudspeaker is deactivated.

Incoming calls are signalled only via the display, the lighting is reduced to 50%. Vibration alarm, ring tones, advisory tones and paging are switched off.

If you accept an incoming call, the baby phone call mode is suspended for the duration of the call, but the function **remains** activated.

The baby phone call is not deactivated by switching the handset off and on again.

Caution

- ◆ **Always check the function when switching on (noise sensitivity, connection to an external number). Please note that the baby phone call is only activated 20 seconds after being switched on.**
- ◆ Place the handset **in the charger** cradle so that the front with the microphone is facing the baby and the distance between the handset and the baby is no more than 1 to 2 metres.
- ◆ No answering machine may be activated at the destination number.

Changing the settings

- ▶ Menu key ▶ [Room Monitor] ▶ Touch [Edit] ▶ Select the sensitivity (**High** or **Low**) and destination of the babyphone call (**Internal** or **External**).
- ▶ Next to **Number** touch ▶ Enter the destination number or select the internal participant.
- ▶ Confirm with ▶ Touch [Save].

Activating/deactivating the baby phone call

- ▶ **Switch on:** Menu key ▶ [Room Monitor] ▶ Touch the key on the right.
- ▶ **Switch off:** On the handset on which the baby phone call is activated, touch the key on the left.

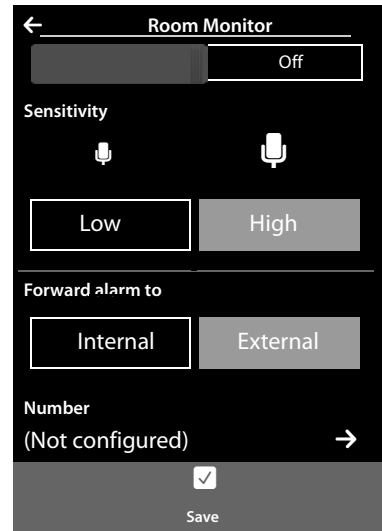

Cancelling the baby phone call

- ▶ During a baby phone call, touch .

Accepting the baby phone call

- ▶ On the destination phone/handset of the alarm call, press the pick-up key or pick up the receiver.

Deactivating the baby phone call remotely

Prerequisites: The destination of the baby phone call is an external number. The recipient's phone supports tone dialling (MFV).

- ▶ Accept the baby phone call and touch the keys.

The call is ended. The baby phone call is deactivated and the handset is in idle mode.

Screensaver, caller pictures and sounds

Mono/polyphonic sounds/ring tones and pictures are saved on the handset (and can be selected as screensavers or caller pictures). You can load additional pictures and sounds onto the handset from your PC (→ Gigaset QuickSync, page 43).

On the menu page **Applications** you will find the media pools **Screensavers**, **Caller Pictures** and **Sounds**, with which you can manage the pictures and sounds saved on your telephone.

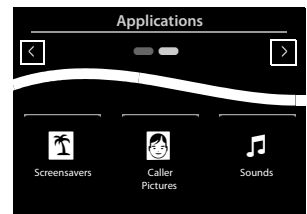

Viewing/deleting pictures

- ▶ Menu key ▶ [Screensavers] / [Caller Pictures] ▶ Drag your finger from right to left or left to right over the display to view the individual pictures.
- ▶ **Delete picture:** Scroll to the picture ▶ Touch [Delete] ▶ Confirm with **Yes**.

Playing back sounds

- ▶ Menu key ▶ Touch [Sounds] ▶ Select a sound.

Synchronising with your PC (Gigaset QuickSync)

You can:

- ◆ Synchronise your handset's Contacts list with your Google contacts online via the cloud
- ◆ Synchronise the Contacts on your handset with your PC's Outlook directory.
- ◆ Load caller pictures to the handset from the PC.
- ◆ Download pictures as a screensaver from the PC to the handset.
- ◆ Download sounds (ring tones) from the PC to the handset.
- ◆ Make outgoing calls and accept incoming calls. The display on the handset behaves in the same way as if the call were being handled directly on the handset.
- ◆ Update the firmware of your Gigaset SL910 handset (via USB only).

You can save the following image and sound formats on your handset:

Sound	Format	Picture	Format
– Ring tones – Imported sounds	Internal WMA, MP3, WAV	– Caller picture – Screensaver	BMP, JPG, GIF 320 x 225 pixels 320 x 480 pixels

To enable your handset to communicate with a PC, the **"Gigaset QuickSync" program (Version 7 or higher)** must be installed on your PC (free download and more information at www.gigaset.com/gigasetSL910).

You can use this program to create a connection between PC and handset via Bluetooth (→ page 1) or USB (→ page 30).

Please note



























- ◆ Firmware can only be updated via a USB connection.
- ◆ If the USB data cable is plugged in, a Bluetooth connection cannot be established. If it is plugged in during an existing Bluetooth connection, this is cancelled.







A detailed description can be found in the **Gigaset QuickSync** help file.

Display icons

Options bar icons

The following functions are available in the options bar depending on the operating situation.

Icon	Action
	Activate speaker mode
 (orange)	(Speaker mode is activated) Deactivate speaker mode
	Speaker profile
	Mute handset microphone
 (orange)	Unmute handset microphone
	Deactivating the ring tone
	Setting the volume
	Open call lists
	Opening Contacts
	Accept number in Contacts
	Deregistering the handset
	Open list of internal callers/make internal call
	Create new Contacts entry
	Initiating a consultation call:
	Initiate/end three-way conference call
	Speed dial
	Copy list
	Copy entry
	Editing entries
	Show keypad
	Determine free memory in the media pool
	Search
	Skip settings
	Deleting
	Save/select
	Enter new appointment







Icon	Action
	Calendar: Set selected date to Today
	Change order (sort by last name or first name)
	Contacts entry: Delete caller ring tone assignment
	Contacts entry: Delete caller picture assignment
	Delete birthday
	Trust Bluetooth device found



Please note

The menu icons can be found in the menu overview on [page 46](#).

Icons in the status bar

The following icons are displayed in the status bar depending on the settings and the operating status of your telephone:

Icon	Meaning
	Signal strength (No Radiation off) 76%–100% } White if Max. Range is on; 51%–75% } green if Max. Range is off 26%–50% } 1%–25% } Red: no connection to the base
	No Radiation activated: white if Max. Range is on; green if Max. Range is off
	Bluetooth activated
	Bluetooth headset/data device connected
	Ring tone deactivated
	Alarm switched on and wake-up time set

Icon	Meaning
	Battery charge status: White: charged over 66% White: charged between 34% and 66% White: charged between 11% and 33% Red: charged below 11% Flashing red: battery almost empty (less than 10 minutes talk time)
	Battery charging (current charge status): 0%–10% 11%–33% 34%–66% 67%–100%

Signalling display icons



Establishing a connection (outgoing call)



Connection established



Connection cannot be established/ connection terminated



Internal/external call



Alarm call



Reminder call for appointment/ birthday

Other display icons



Information



(Security) prompt



Please wait...



Action complete (green)



Warning



Action failed (red)



Setting options (depending on the base)



Open the **Settings** menu page:

- ▶ Briefly press menu key **O** when the handset is in idle mode.
- ▶ Drag your finger horizontally across the display to switch to the **Settings** menu page.









Please note

Not all of the functions described in this user guide are available in all countries.

Main menu Settings	Submenu Current setting	Additional setting options	Page
 Date + Time	Time	Time Time Format 24 hrs 12 hrs	page 24
	Date	Date Date Order	
 Audio Settings	Ringtones Int Ext	Volume Crescendo Int. Calls Ext. Calls Time Ctrl (Ringer Off) Anon. Call Silenc.	
	Silent Alert		
	Reminder Signal	Volume Crescendo Sound	
	Advisory Tones		
	Confirmations		
	Battery Warning		
	Music on Hold		

Main menu Settings	Submenu Current setting	Additional setting options	Page					
 Display + Keypad	Screensaver Activation Selection	<table border="1"> <tr><td>Slideshow</td></tr> <tr><td>Analogue Clock</td></tr> <tr><td>Digital Clock 1</td></tr> <tr><td>Digital Clock 2</td></tr> <tr><td>(List of Screensavers images)</td></tr> </table>	Slideshow	Analogue Clock	Digital Clock 1	Digital Clock 2	(List of Screensavers images)	page 23
	Slideshow							
	Analogue Clock							
	Digital Clock 1							
	Digital Clock 2							
	(List of Screensavers images)							
	Backlight In Charger Out of Charger Timeout	<table border="1"> <tr><td>15 sec. / 30 sec. / 1 min. / 2 min.</td></tr> </table>	15 sec. / 30 sec. / 1 min. / 2 min.	page 23				
	15 sec. / 30 sec. / 1 min. / 2 min.							
	Number Info in Dial Lists	<table border="1"> <tr><td>Number Type Only</td></tr> <tr><td>Type and Number</td></tr> </table>	Number Type Only	Type and Number				
	Number Type Only							
Type and Number								
Indication of New Messages LED + Display Info								
Keypad Key Tones Key Vibration Keypad with R/P Keypad w. Letters		page 23						
 Language + Location	Display Language	List of available languages	page 23					
	Country	List of countries						
	Country (Dial Code)	Only if Country = Other Country						
	Area (Dial Code)							

Setting options (depending on the base)

Main menu Settings	Submenu Current setting	Additional setting options	Page
 Handsets + Base	This Handset		page 6
	Register		
	De-register		
	Rename		
	Registered Handsets (List of registered handsets)	(Only if more than one handset is registered)	
	Connected to Base	Base 1 : Base 4 Best Base	page 28
 System Services	Dependent on base		
 Select Services	Dependent on base		
 Telephony Services	Dependent on base		
 SMS Service Centres Services	Dependent on base		
 Bluetooth	Own Device		page 30
	Known Devices		
	Activation		
	Devices found (only if Activation = on)	Device Name	
 Answer Machine Services	Dependent on base		
 Network Mailbox	On / Off	Provider-specific	page 27
	Access Number		

Customer Service & Assistance

Do you have any questions? As a Gigaset customer, you can find help quickly in this User Manual and in the service section of our Gigaset online portal www.gigaset.com/service.

Please register your phone online right after purchase.

This enables us to provide you with even better service regarding questions or a warranty claim. In order to contact our customer service via email, please use the email contact form from our Gigaset online portal after selecting your home country.

Our representatives are also available on the telephone hotlines for consultation.

Australia ----- **+61 1300 780 878**

Austria ----- **0043 1 311 3046**

Bahrain ----- **31 73 11 173**

Belgium ----- **07815 6679**

Bosnia Herzegovina ----- **033 276 649**

Brazil

Grandes Capitais e Regiões Metropolitanas:

----- **4003 3020**

(Preço de uma ligação local)

----- Demais localidades:

----- **0800 888 3020**

(Gratuito)

Bulgaria ----- **+359 2 9710666**

Canada ----- **1-866 247-8758**

China ----- **0 21 400 670 6007** (RMB 0.11)

Croatia ----- **01 / 2456 555**

Czech Republic----- **233 032 727**

Denmark ----- **+45 43682003**

Finland ----- **+358 (0)9725 19734**

France----- **+33 (0)157 324 522**

Germany----- **01805 333 222**

Greece ----- **+30 2111 98 1778**

Hong Kong----- **2763 0203**

-----2389 7285

Hungary ----- **(06-1) 267 2109** (27 Ft)

India ----- Please refer to your

-----local warranty card

Indonesia ----- **(62-21) 5673813**

----- **(62-21) 888856000**

Ireland ----- **+353 818 200 033**

Italy ----- **199.15.11.15**

(€ cent 8,36 + IVA al minuto da telefono fisso della rete Telecom Italia senza scatto alla risposta mentre per le chiamate effettuate attraverso la rete di altri operatori fissi o mobili consultate le tariffe del vostro operatore)

Jordan----- **00962 6 5625460/1/2**

Kuwait----- **+965 -22458737/22458738**

Lebanon ----- **+9611240259/**

----- **+9611236110**

Luxembourg----- **(+352) 8002 3811**

Malaysia ----- **+603-8076 9696**

Malta----- **+39 02360 46111** (0,10 €)

Mexico

01800 999 4442738 (01800 999 GIGASET)

Netherlands ----- **0900-3333102**

New Zealand----- **0800 780 878**

Norway ----- **+47 2231 0845**

Oman ----- **+968 70928 Ext. 49/21/75**

Poland----- **801 140 160**

Portugal - **+351 808 788 877** (custo de uma

chamada local)

Romania ----- **+40 021 204 9130**

Russia ----- **8-800 333 4956**

Serbia ----- **0800 222 111**

Singapore ----- **6735 9100**

Slovak Republic----- **044 5567 988 alebo**

----- **02 59682266**

Slovenija ----- **01 5466 511**

South Africa----- **0800 98 08 42**

Spain ----- **902 103935**

Sweden ----- **+46 (0)8502 52347**

Switzerland ----- **0848 212 000**

Taiwan----- **02 266 24343**

Turkey ----- **+90 216 223 01 57**

Ukraine ----- **+380-44-451-71-72**

United Arab Emirates ----- **+97144458255**

----- **+97144458254**

United Kingdom ----- **+44 84503 18190**

USA ----- **1-866 247-8758**

----- tollfree

Please have your record of purchase ready when calling.

Replacement or repair services are not offered in countries where our product is not sold by authorised dealers.



Questions and answers

If you have any queries about the use of the telephone, suggested solutions are available on the Internet at

www.gigaset.com/service

▶ FAQ ▶ First steps for troubleshooting

The table below also lists steps for troubleshooting.

<p>Registration or connection problems with a Bluetooth headset.</p> <ul style="list-style-type: none">▶ Reset the Bluetooth headset (see the user guide for your headset).▶ Delete registration data from the handset when de-registering the device (→ page 31).▶ Repeat the registration process (→ page 30).
<p>There is nothing on the display and the display does not react when you touch it.</p> <ol style="list-style-type: none">1. The handset is not activated.<ul style="list-style-type: none">▶ Press and hold .2. The battery is flat.<ul style="list-style-type: none">▶ Charge or replace the battery (→ page 5).3. The keypad and display lock is activated.<ul style="list-style-type: none">▶ Press and hold the menu key .
<p>"Base connection lost - Searching for base ... " flashes on the display.</p> <ol style="list-style-type: none">1. The handset is outside the range of the base.<ul style="list-style-type: none">▶ Move the handset closer to the base.2. The base is not activated.<ul style="list-style-type: none">▶ Check the base power adapter.3. The base's range is reduced because Eco Mode is activated.<ul style="list-style-type: none">▶ Deactivate Eco Mode (→ page 26) or reduce the distance between the handset and the base.
<p>"Handset not registered to any base" flashes on the display.</p> <p>The handset has not yet been registered or was de-registered because an additional handset was registered.</p> <ul style="list-style-type: none">▶ Register the handset again (→ page 6).
<p>The handset does not ring.</p> <ol style="list-style-type: none">1. The ring tone is deactivated.<ul style="list-style-type: none">▶ Activate the ring tone (→ page 25).2. Call divert is set to "All Calls".<ul style="list-style-type: none">▶ Deactivate call divert .3. The phone does not ring if the caller has withheld his number.<ul style="list-style-type: none">▶ Activate the ring tone for unknown calls.4. Telephone does not ring in a certain period of time.<ul style="list-style-type: none">▶ Time control for external calls is activated (→ page 25).
<p>The other party cannot hear you.</p> <p>The handset is "muted".</p> <ul style="list-style-type: none">▶ Unmute the microphone (→ page 22).

The caller's number is not displayed.

1. **Calling Line Identification (CLI)** is not enabled for the caller.
 - ▶ The **caller** should ask his network provider to enable Calling Line Identification (CLI).
2. **Calling line display (CLIP)** is not supported by the network provider or has not been enabled for you.
 - ▶ Have calling line display (CLIP) enabled by your network provider.
3. Your telephone is connected via a PABX or a router with an integrated PABX (gateway) that does not transmit all information.
 - ▶ Reset the system: briefly pull out the power plug. Reinsert the plug and wait until the device restarts.
 - ▶ Check the settings on the PABX and activate phone number display, if necessary. To do this, search for terms such as CLIP, calling line identification, phone number identification, caller ID etc. in the system's user guide or ask the system manufacturer.

You hear an error tone when keying an input.

Action has failed/invalid input.

- ▶ Repeat the process.
- ▶ Read the display and refer to the user guide if necessary.

You cannot listen to messages on the network mailbox.

Your PABX is set to pulse dialling.

- ▶ Set your PABX to tone dialling.

Check handset service information

You will need the service information if you call our hotline.

Prerequisite: A call is not in progress.

- ▶ **Briefly** touch any point in the status bar and then touch **Show Service Info**.

Authorisation

This device is intended for use within the European Economic Area and Switzerland. If used in other countries, it must first be approved nationally in the country in question.

Country-specific requirements have been taken into consideration.

We, Gigaset Communications GmbH, declare that this device meets the essential requirements and other relevant regulations laid down in Directive 1999/5/EC.

A copy of the Declaration of Conformity is available at this Internet address:

www.gigaset.com/docs

CE 0682

Exclusion of liability

The display on your handset has a resolution of 480x320 pixels, which is achieved with the aid of 460,800 control elements. Each pixel consists of three subpixels (red, green, blue).

It may be the case that a pixel is incorrectly controlled or has a colour deviation. **This is normal and no reason for a warranty claim.**

Environment

The following table shows the number of pixel errors that may occur without leading to a warranty claim.

Description	Maximum number of permitted pixel errors
Colour illuminated subpixels	1
Dark subpixels	1
Total number of coloured and dark subpixels	1

Please note

Signs of wear on the display and housing are excluded from the warranty.

Environment

Our environmental statement

We at Gigaset Communications GmbH are aware of our social responsibility. That is why we actively take steps to create a better world. In all areas of our business – from product planning and production to sales and waste of disposal – following our environmental conscience in everything we do is of utmost importance to us.

Learn more about our earth-friendly products and processes online at www.gigaset.com.

Environmental management system



Gigaset Communications GmbH is certified pursuant to the international standards ISO 14001 and ISO 9001.

ISO 14001 (Environment): Certified since September 2007 by TÜV SÜD Management Service GmbH.

ISO 9001 (Quality): Certified since 17/02/1994 by TÜV SÜD Management Service GmbH.

Disposal

Batteries should not be disposed of in general household waste. Observe the local waste disposal regulations, details of which can be obtained from your local authority.

All electrical and electronic equipment must be disposed of separately from general household waste using the sites designated by local authorities.



If a product displays this symbol of a crossed-out rubbish bin, the product is subject to European Directive 2002/96/EC.

The appropriate disposal and separate collection of used equipment serve to prevent potential harm to the environment and to health. They are a precondition for the re-use and recycling of used electrical and electronic equipment.

For further information on disposing of your used equipment, please contact your local authority or your refuse collection service.

Appendix

Care

Wipe the device with a **damp** cloth or an antistatic cloth. Do not use solvents or microfibre cloths.

Never use a dry cloth; this can cause static.

In rare cases, contact with chemical substances can cause changes to the device's exterior. Due to the wide variety of chemical products available on the market, it was not possible to test all substances.

Impairments in high-gloss finishes can be carefully removed using display polishes for mobile phones.

Contact with liquid

If the device comes into contact with liquid:

- 1 Disconnect the power supply.**
- 2 Remove the batteries and leave the battery compartment open.**
- 3 Allow the liquid to drain from the device.
- 4 Pat all parts dry.
- 5 Place the device in a dry, warm place **for at least 72 hours (not in a microwave, oven etc.)** with the battery compartment open and the keypad facing down (if applicable).
- 6 Do not switch on the device again until it is completely dry.**

When it has fully dried out, you will normally be able to use it again.

Specifications

Battery

Technology: Lithium ion (Li-Ion):

Voltage: 3.7 V

Capacity: 1000 mAh

Type: V30145-K1310-X447

Due to the constant progression in battery development, the list of recommended batteries in the FAQ section of the Gigaset Customer Care pages is updated regularly:

www.gigaset.com/service

Handset operating times/charging times

The operating time of your Gigaset depends on the capacity and age of the battery and the way it is used. (All times are maximum possible times.)

Standby time (hours) *	200
Standby time in Eco mode+ (hours) *	130
Talktime (hours)	14
Operating time for 1.5 hours of calls per day (hours) *	106
Operating time in Eco mode+ for 1.5 hours of calls per day (hours) *	75
Charging time in charger cradle (hours)	5

* Without display backlight

Information about the USB port

- ◆ The handset's battery is charged using a USB connection with a power supply of 500 mA.
- ◆ **On USB connections with lower charging currents, the consumption of the handset itself may be greater than the recharging. In this case, the battery charge decreases.**

General specifications

DECT

DECT standard	Supported
GAP standard	Supported
No. of channels	60 duplex channels
Radio frequency range	1880 – 1900 MHz
Duplex method	Time division multiplexing, 10 ms frame length
Repeat frequency of the transmission pulse	100 Hz
Length of the transmission pulse	370 µs
Channel grid	1728 kHz
Bit rate	1152 kbit/s
Modulation	GFSK
Language code	32 kbit/s
Transmission power	10 mW average power per channel, 250 mW pulse power
Range	Up to 50 m in buildings, up to 300 m outdoors
Ambient conditions for operation	+5°C to +45°C, 20% to 75% relative humidity

Bluetooth

Radio frequency range	2402–2480 MHz
Transmission power	1 mW pulse power

Open Source software

General

Your Gigaset unit includes, among other things, Open Source software that is subject to various licence conditions. The granting of rights of use with regard to the Open Source software that go beyond the operation of the unit in the form produced by Gigaset Communications GmbH is regulated in the relevant licence conditions of the Open Source Software.

Licence and copyright information

Your Gigaset unit includes Open Source software which is subject to the GNU General Public License (GPL) or the GNU Lesser General Public License (LGPL). The corresponding licence conditions are printed at the end of this chapter in their original version. You can download the corresponding source code from the Internet at www.gigaset.com/opensource/. Within three years after the product is purchased, the corresponding source code can also be requested from Gigaset Communications GmbH. Please use the contact options specified at www.gigaset.com/service.

Licence texts

GNU GENERAL PUBLIC LICENSE

Version 2, June 1991

Copyright© 1989, 1991 Free Software Foundation, Inc., 51 Franklin Street, Fifth Floor, Boston, MA 02110-1301 USA

Everyone is permitted to copy and distribute verbatim copies of this license document, but changing it is not allowed.

Preamble

The licenses for most software are designed to take away your freedom to share and change it. By contrast, the GNU General Public License is intended to guarantee your freedom to share and change free software—to make sure the software is free for all its users. This General Public License applies to most of the Free Software Foundation's software and to any other program whose authors commit to using it. (Some other Free Software Foundation software is covered by the GNU Lesser General Public License instead.) You can apply it to your programs, too.

When we speak of free software, we are referring to freedom, not price. Our General Public Licenses are designed to make sure that you have the freedom to distribute copies of free software (and charge for this service if you wish), that you receive source code or can get it if you want it, that you can change the software or use pieces of it in new free programs; and that you know you can do these things.

To protect your rights, we need to make restrictions that forbid anyone to deny you these rights or to ask you to surrender the rights. These restrictions translate to certain responsibilities for you if you distribute copies of the software, or if you modify it.

For example, if you distribute copies of such a program, whether gratis or for a fee, you must give the recipients all the rights that you have. You must make sure that they, too, receive or can get the source code. And you must show them these terms so they know their rights.

We protect your rights with two steps: (1) copyright the software, and (2) offer you this license which gives you legal permission to copy, distribute and/or modify the software.

Also, for each author's protection and ours, we want to make certain that everyone understands that there is no warranty for this free software. If the software is modified by someone else and passed on, we want its recipients to know that what they have is not the original, so that any problems introduced by others will not reflect on the original authors' reputations.

Finally, any free program is threatened constantly by software patents. We wish to avoid the danger that redistributors of a free program will individually obtain patent licenses, in effect making the program proprietary. To prevent this, we have made it clear that any patent must be licensed for everyone's free use or not licensed at all.

The precise terms and conditions for copying, distribution and modification follow.

TERMS AND CONDITIONS FOR COPYING, DISTRIBUTION AND MODIFICATION

0. This License applies to any program or other work which contains a notice placed by the copyright holder saying it may be distributed under the terms of this General Public License. The "Program", below, refers to any such program or work, and a "work based on the Program" means either the Program or any derivative work under copyright law: that is to say, a work containing the Program or a portion of it, either verbatim or with modifications and/or translated into another language. (Hereinafter, translation is included without limitation in the term "modification".) Each licensee is addressed as "you".

Open Source software

Activities other than copying, distribution and modification are not covered by this License; they are outside its scope. The act of running the Program is not restricted, and the output from the Program is covered only if its contents constitute a work based on the Program (independent of having been made by running the Program). Whether that is true depends on what the Program does.

1. You may copy and distribute verbatim copies of the Program's source code as you receive it, in any medium, provided that you conspicuously and appropriately publish on each copy an appropriate copyright notice and disclaimer of warranty; keep intact all the notices that refer to this License and to the absence of any warranty; and give any other recipients of the Program a copy of this License along with the Program.

You may charge a fee for the physical act of transferring a copy, and you may at your option offer warranty protection in exchange for a fee.

2. You may modify your copy or copies of the Program or any portion of it, thus forming a work based on the Program, and copy and distribute such modifications or work under the terms of Section 1 above, provided that you also meet all of these conditions:

- a) You must cause the modified files to carry prominent notices stating that you changed the files and the date of any change.
- b) You must cause any work that you distribute or publish, that in whole or in part contains or is derived from the Program or any part thereof, to be licensed as a whole at no charge to all third parties under the terms of this License.
- c) If the modified program normally reads commands interactively when run, you must cause it, when started running for such interactive use in the most ordinary way, to print or display an announcement including an appropriate copyright notice and a notice that there is no warranty (or else, saying that you provide a warranty) and that users may redistribute the program under these conditions, and telling the user how to view a copy of this License. (Exception: if the Program itself is interactive but does not normally print such an announcement, your work based on the Program is not required to print an announcement.)

These requirements apply to the modified work as a whole. If identifiable sections of that work are not derived from the Program, and can be reasonably considered independent and separate works in themselves, then this License, and its terms, do not apply to those sections when you distribute them as separate works. But when you distribute the same sections as part of a whole which is a work based on the Program, the distribution of the whole must be on the terms of this License, whose permissions for other licensees extend to the entire whole, and thus to each and every part regardless of who wrote it.

Thus, it is not the intent of this section to claim rights or contest your rights to work written entirely by you; rather, the intent is to exercise the right to control the distribution of derivative or collective works based on the Program.

In addition, mere aggregation of another work not based on the Program with the Program (or with a work based on the Program) on a volume of a storage or distribution medium does not bring the other work under the scope of this License.

3. You may copy and distribute the Program (or a work based on it, under Section 2) in object code or executable form under the terms of Sections 1 and 2 above provided that you also do one of the following:

- a) Accompany it with the complete corresponding machine-readable source code, which must be distributed under the terms of Sections 1 and 2 above on a medium customarily used for software interchange; or,
- b) Accompany it with a written offer, valid for at least three years, to give any third party, for a charge no more than your cost of physically performing source distribution, a complete machine-readable copy of the corresponding source code, to be distributed under the terms of Sections 1 and 2 above on a medium customarily used for software interchange; or,
- c) Accompany it with the information you received as to the offer to distribute corresponding source code. (This alternative is allowed only for noncommercial distribution and only if you received the program in object code or executable form with such an offer, in accord with Sub-section b above.)

The source code for a work means the preferred form of the work for making modifications to it. For an executable work, complete source code means all the source code for all modules it contains, plus any associated interface definition files, plus the scripts used to control compilation and installation of the executable. However, as a special exception, the source code distributed need not include anything that is normally distributed (in either source or binary form) with the major components (compiler, kernel, and so on) of the operating system on which the executable runs, unless that component itself accompanies the executable.

If distribution of executable or object code is made by offering access to copy from a designated place, then offering equivalent access to copy the source code from the same place counts as distribution of the source code, even though third parties are not compelled to copy the source along with the object code.

4. You may not copy, modify, sublicense, or distribute the Program except as expressly provided under this License. Any attempt otherwise to copy, modify, sublicense or distribute the Program is void, and will automatically terminate your rights under this License. However, parties who have received copies, or rights, from you under this License will not have their licenses terminated so long as such parties remain in full compliance.

5. You are not required to accept this License, since you have not signed it. However, nothing else grants you permission to modify or distribute the Program or its derivative works. These actions are prohibited by law if you do not accept this License. Therefore, by modifying or distributing the Program (or any work based on the Program), you indicate your acceptance of this License to do so, and all its terms and conditions for copying, distributing or modifying the Program or works based on it.

6. Each time you redistribute the Program (or any work based on the Program), the recipient automatically receives a license from the original licensor to copy, distribute or modify the Program subject to these terms and conditions. You may not impose any further restrictions on the recipients' exercise of the rights granted herein. You are not responsible for enforcing compliance by third parties to this License.

7. If, as a consequence of a court judgment or allegation of patent infringement or for any other reason (not limited to patent issues), conditions are imposed on you (whether by court order, agreement or otherwise) that contradict the conditions of this License, they do not excuse you from the conditions of this License. If you cannot distribute so as to satisfy simultaneously your obligations under this License and any other pertinent obligations, then as a consequence you may not distribute the Program at all. For example, if a patent license would not permit royalty-free redistribution of the Program by all those who receive copies directly or indirectly through you, then the only way you could satisfy both it and this License would be to refrain entirely from distribution of the Program.

If any portion of this section is held invalid or unenforceable under any particular circumstance, the balance of the section is intended to apply and the section as a whole is intended to apply in other circumstances.

It is not the purpose of this section to induce you to infringe any patents or other property right claims or to contest validity of any such claims; this section has the sole purpose of protecting the integrity of the free software distribution system, which is implemented by public license practices. Many people have made generous contributions to the wide range of software distributed through that system in reliance on consistent application of that system; it is up to the author/donor to decide if he or she is willing to distribute software through any other system and a licensee cannot impose that choice.

This section is intended to make thoroughly clear what is believed to be a consequence of the rest of this License.

8. If the distribution and/or use of the Program is restricted in certain countries either by patents or by copyrighted interfaces, the original copyright holder who places the Program under this License may add an explicit geographical distribution limitation excluding those countries, so that distribution is permitted only in or among countries not thus excluded. In such case, this License incorporates the limitation as if written in the body of this License.

9. The Free Software Foundation may publish revised and/or new versions of the General Public License from time to time. Such new versions will be similar in spirit to the present version, but may differ in detail to address new problems or concerns.

Each version is given a distinguishing version number. If the Program specifies a version number of this License which applies to it and "any later version", you have the option of following the terms and conditions either of that version or of any later version published by the Free Software Foundation. If the Program does not specify a version number of this License, you may choose any version ever published by the Free Software Foundation.

10. If you wish to incorporate parts of the Program into other free programs whose distribution conditions are different, write to the author to ask for permission. For software which is copyrighted by the Free Software Foundation, write to the Free Software Foundation; we sometimes make exceptions for this. Our decision will be guided by the two goals of preserving the free status of all derivatives of our free software and of promoting the sharing and reuse of software generally.

NO WARRANTY

11. BECAUSE THE PROGRAM IS LICENSED FREE OF CHARGE, THERE IS NO WARRANTY FOR THE PROGRAM, TO THE EXTENT PERMITTED BY APPLICABLE LAW. EXCEPT WHEN OTHERWISE STATED IN WRITING THE COPYRIGHT HOLDERS AND/OR OTHER PARTIES PROVIDE THE PROGRAM "AS IS" WITHOUT WARRANTY OF ANY KIND, EITHER EXPRESSED OR IMPLIED, INCLUDING, BUT NOT LIMITED TO, THE IMPLIED WARRANTIES OF MERCHANTABILITY AND FITNESS FOR A PARTICULAR PURPOSE. THE ENTIRE RISK AS TO THE QUALITY AND PERFORMANCE OF THE PROGRAM IS WITH YOU. SHOULD THE PROGRAM PROVE DEFECTIVE, YOU ASSUME THE COST OF ALL NECESSARY SERVICING, REPAIR OR CORRECTION.

12. IN NO EVENT UNLESS REQUIRED BY APPLICABLE LAW OR AGREED TO IN WRITING WILL ANY COPYRIGHT HOLDER, OR ANY OTHER PARTY WHO MAY MODIFY AND/OR REDISTRIBUTE THE PROGRAM AS PERMITTED ABOVE, BE LIABLE TO YOU FOR DAMAGES, INCLUDING ANY GENERAL, SPECIAL, INCIDENTAL OR CONSEQUENTIAL DAMAGES ARISING OUT OF THE USE OR INABILITY TO USE THE PROGRAM (INCLUDING BUT NOT LIMITED TO LOSS OF DATA OR DATA BEING RENDERED INACCURATE OR LOSSES SUSTAINED BY YOU OR THIRD PARTIES OR A FAILURE OF THE PROGRAM TO OPERATE WITH ANY OTHER PROGRAMS), EVEN IF SUCH HOLDER OR OTHER PARTY HAS BEEN ADVISED OF THE POSSIBILITY OF SUCH DAMAGES.

END OF TERMS AND CONDITIONS

How to Apply These Terms to Your New Programs

If you develop a new program, and you want it to be of the greatest possible use to the public, the best way to achieve this is to make it free software which everyone can redistribute and change under these terms.

To do so, attach the following notices to the program. It is safest to attach them to the start of each source file to most effectively convey the exclusion of warranty; and each file should have at least the "copyright" line and a pointer to where the full notice is found.

<one line to give the program's name and a brief idea of what it does.>
Copyright © <year> <name of author>

This program is free software; you can redistribute it and/or modify it under the terms of the GNU General Public License as published by the Free Software Foundation; either version 2 of the License, or (at your option) any later version.

This program is distributed in the hope that it will be useful, but WITHOUT ANY WARRANTY; without even the implied warranty of MERCHANTABILITY or FITNESS FOR A PARTICULAR PURPOSE. See the GNU General Public License for more details.

Open Source software

You should have received a copy of the GNU General Public License along with this program; if not, write to the Free Software Foundation, Inc., 51 Franklin Street, Fifth Floor, Boston, MA 02110-1301 USA.

Also add information on how to contact you by electronic and paper mail.

If the program is interactive, make it output a short notice like this when it starts in an interactive mode:

```
Gnomovision version 69, Copyright © year name of author
```

```
Gnomovision comes with ABSOLUTELY NO WARRANTY; for details type `show w`.
```

```
This is free software, and you are welcome to redistribute it under certain conditions; type `show c` for details.
```

The hypothetical commands `show w` and `show c` should show the appropriate parts of the General Public License. Of course, the commands you use may be called something other than `show w` and `show c`; they could even be mouse-clicks or menu items--whatever suits your program.

You should also get your employer (if you work as a programmer) or your school, if any, to sign a "copyright disclaimer" for the program, if necessary. Here is a sample; alter the names:

```
Yoyodyne, Inc., hereby disclaims all copyright interest in the program `Gnomovision' (which makes passes at compilers) written by James Hacker.
```

```
<signature of Ty Coon>, 1 April 1989
```

```
Ty Coon, President of Vice
```

This General Public License does not permit incorporating your program into proprietary programs. If your program is a subroutine library, you may consider it more useful to permit linking proprietary applications with the library. If this is what you want to do, use the GNU Lesser General Public License instead of this License.

GNU LESSER GENERAL PUBLIC LICENSE

Version 2.1, February 1999

Copyright © 1991, 1999 Free Software Foundation, Inc. 51 Franklin Street, Fifth Floor, Boston, MA 02110-1301 USA

Everyone is permitted to copy and distribute verbatim copies of this license document, but changing it is not allowed.

[This is the first released version of the Lesser GPL. It also counts as the successor of the GNU Library Public License, version 2, hence the version number 2.1.]

Preamble

The licenses for most software are designed to take away your freedom to share and change it. By contrast, the GNU General Public Licenses are intended to guarantee your freedom to share and change free software--to make sure the software is free for all its users.

This license, the Lesser General Public License, applies to some specially designated software packages--typically libraries--of the Free Software Foundation and other authors who decide to use it. You can use it too, but we suggest you first think carefully about whether this license or the ordinary General Public License is the better strategy to use in any particular case, based on the explanations below.

When we speak of free software, we are referring to freedom of use, not price. Our General Public Licenses are designed to make sure that you have the freedom to distribute copies of free software (and charge for this service if you wish); that you receive source code or can get it if you want it; that you can change the software and use pieces of it in new free programs; and that you are informed that you can do these things.

To protect your rights, we need to make restrictions that forbid distributors to deny you these rights or to ask you to surrender these rights. These restrictions translate to certain responsibilities for you if you distribute copies of the library or if you modify it.

For example, if you distribute copies of the library, whether gratis or for a fee, you must give the recipients all the rights that we gave you. You must make sure that they, too, receive or can get the source code. If you link other code with the library, you must provide complete object files to the recipients, so that they can relink them with the library after making changes to the library and recompiling it. And you must show them these terms so they know their rights.

We protect your rights with a two-step method: (1) we copyright the library, and (2) we offer you this license, which gives you legal permission to copy, distribute and/or modify the library.

To protect each distributor, we want to make it very clear that there is no warranty for the free library. Also, if the library is modified by someone else and passed on, the recipients should know that what they have is not the original version, so that the original author's reputation will not be affected by problems that might be introduced by others.

Finally, software patents pose a constant threat to the existence of any free program. We wish to make sure that a company cannot effectively restrict the users of a free program by obtaining a restrictive license from a patent holder. Therefore, we insist that any patent license obtained for a version of the library must be consistent with the full freedom of use specified in this license.

Most GNU software, including some libraries, is covered by the ordinary GNU General Public License. This license, the GNU Lesser General Public License, applies to certain designated libraries, and is quite different from the ordinary General Public License. We use this license for certain libraries in order to permit linking those libraries into non-free programs.

When a program is linked with a library, whether statically or using a shared library, the combination of the two is legally speaking a combined work, a derivative of the original library. The ordinary General Public License therefore permits such linking only if the entire combination fits its criteria of freedom. The Lesser General Public License permits more lax criteria for linking other code with the library.

We call this license the "Lesser" General Public License because it does Less to protect the user's freedom than the ordinary General Public License. It also provides other free software developers Less of an advantage over competing non-free programs. These disadvantages are the reason we use the ordinary General Public License for many libraries. However, the Lesser license provides advantages in certain special circumstances.

For example, on rare occasions, there may be a special need to encourage the widest possible use of a certain library, so that it becomes a de-facto standard. To achieve this, non-free programs must be allowed to use the library. A more frequent case is that a free library does the same job as widely used non-free libraries. In this case, there is little to gain by limiting the free library to free software only, so we use the Lesser General Public License.

In other cases, permission to use a particular library in non-free programs enables a greater number of people to use a large body of free software. For example, permission to use the GNU C Library in non-free programs enables many more people to use the whole GNU operating system, as well as its variant, the GNU/Linux operating system.

Although the Lesser General Public License is Less protective of the users' freedom, it does ensure that the user of a program that is linked with the Library has the freedom and the wherewithal to run that program using a modified version of the Library.

The precise terms and conditions for copying, distribution and modification follow. Pay close attention to the difference between a "work based on the library" and a "work that uses the library". The former contains code derived from the library, whereas the latter must be combined with the library in order to run.

TERMS AND CONDITIONS FOR COPYING, DISTRIBUTION AND MODIFICATION

0. This License Agreement applies to any software library or other program which contains a notice placed by the copyright holder or other authorized party saying it may be distributed under the terms of this Lesser General Public License (also called "this License"). Each licensee is addressed as "you".

A "library" means a collection of software functions and/or data prepared so as to be conveniently linked with application programs (which use some of those functions and data) to form executables.

The "Library", below, refers to any such software library or work which has been distributed under these terms. A "work based on the Library" means either the Library or any derivative work under copyright law: that is to say, a work containing the Library or a portion of it, either verbatim or with modifications and/or translated straightforwardly into another language. (Hereinafter, translation is included without limitation in the term "modification".)

"Source code" for a work means the preferred form of the work for making modifications to it. For a library, complete source code means all the source code for all modules it contains, plus any associated interface definition files, plus the scripts used to control compilation and installation of the library.

Activities other than copying, distribution and modification are not covered by this License; they are outside its scope. The act of running a program using the Library is not restricted, and output from such a program is covered only if its contents constitute a work based on the Library (independent of the use of the Library in a tool for writing it). Whether that is true depends on what the Library does and what the program that uses the Library does.

1. You may copy and distribute verbatim copies of the Library's complete source code as you receive it, in any medium, provided that you conspicuously and appropriately publish on each copy an appropriate copyright notice and disclaimer of warranty; keep intact all the notices that refer to this License and to the absence of any warranty; and distribute a copy of this License along with the Library.

You may charge a fee for the physical act of transferring a copy, and you may at your option offer warranty protection in exchange for a fee.

2. You may modify your copy or copies of the Library or any portion of it, thus forming a work based on the Library, and copy and distribute such modifications or work under the terms of Section 1 above, provided that you also meet all of these conditions:

- a) The modified work must itself be a software library.
- b) You must cause the files modified to carry prominent notices stating that you changed the files and the date of any change.
- c) You must cause the whole of the work to be licensed at no charge to all third parties under the terms of this License.
- d) If a facility in the modified Library refers to a function or a table of data to be supplied by an application program that uses the facility, other than as an argument passed when the facility is invoked, then you must make a good faith effort to ensure that, in the event an application does not supply such function or table, the facility still operates, and performs whatever part of its purpose remains meaningful.

(For example, a function in a library to compute square roots has a purpose that is entirely well-defined independent of the application. Therefore, Subsection 2d requires that any application-supplied function or table used by this function must be optional: if the application does not supply it, the square root function must still compute square roots.)

Open Source software

These requirements apply to the modified work as a whole. If identifiable sections of that work are not derived from the Library, and can be reasonably considered independent and separate works in themselves, then this License, and its terms, do not apply to those sections when you distribute them as separate works. But when you distribute the same sections as part of a whole which is a work based on the Library, the distribution of the whole must be on the terms of this License, whose permissions for other licensees extend to the entire whole, and thus to each and every part regardless of who wrote it.

Thus, it is not the intent of this section to claim rights or contest your rights to work written entirely by you; rather, the intent is to exercise the right to control the distribution of derivative or collective works based on the Library.

In addition, mere aggregation of another work not based on the Library with the Library (or with a work based on the Library) on a volume of a storage or distribution medium does not bring the other work under the scope of this License.

3. You may opt to apply the terms of the ordinary GNU General Public License instead of this License to a given copy of the Library. To do this, you must alter all the notices that refer to this License, so that they refer to the ordinary GNU General Public License, version 2, instead of to this License. (If a newer version than version 2 of the ordinary GNU General Public License has appeared, then you can specify that version instead if you wish.) Do not make any other change in these notices.

Once this change is made in a given copy, it is irreversible for that copy, so the ordinary GNU General Public License applies to all subsequent copies and derivative works made from that copy.

This option is useful when you wish to copy part of the code of the Library into a program that is not a library.

4. You may copy and distribute the Library (or a portion or derivative of it, under Section 2) in object code or executable form under the terms of Sections 1 and 2 above provided that you accompany it with the complete corresponding machine-readable source code, which must be distributed under the terms of Sections 1 and 2 above on a medium customarily used for software interchange.

If distribution of object code is made by offering access to copy from a designated place, then offering equivalent access to copy the source code from the same place satisfies the requirement to distribute the source code, even though third parties are not compelled to copy the source along with the object code.

5. A program that contains no derivative of any portion of the Library, but is designed to work with the Library by being compiled or linked with it, is called a "work that uses the Library". Such a work, in isolation, is not a derivative work of the Library, and therefore falls outside the scope of this License.

However, linking a "work that uses the Library" with the Library creates an executable that is a derivative of the Library (because it contains portions of the Library), rather than a "work that uses the library". The executable is therefore covered by this License. Section 6 states terms for distribution of such executables.

When a "work that uses the Library" uses material from a header file that is part of the Library, the object code for the work may be a derivative work of the Library even though the source code is not. Whether this is true is especially significant if the work can be linked without the Library, or if the work is itself a library. The threshold for this to be true is not precisely defined by law.

If such an object file uses only numerical parameters, data structure layouts and accessors, and small macros and small inline functions (ten lines or less in length), then the use of the object file is unrestricted, regardless of whether it is legally a derivative work. (Executables containing this object code plus portions of the Library will still fall under Section 6.)

Otherwise, if the work is a derivative of the Library, you may distribute the object code for the work under the terms of Section 6. Any executables containing that work also fall under Section 6, whether or not they are linked directly with the Library itself.

6. As an exception to the Sections above, you may also combine or link a "work that uses the Library" with the Library to produce a work containing portions of the Library, and distribute that work under terms of your choice, provided that the terms permit modification of the work for the customer's own use and reverse engineering for debugging such modifications.

You must give prominent notice with each copy of the work that the Library is used in it and that the Library and its use are covered by this License. You must supply a copy of this License. If the work during execution displays copyright notices, you must include the copyright notice for the Library among them, as well as a reference directing the user to the copy of this License. Also, you must do one of these things:

a) Accompany the work with the complete corresponding machine-readable source code for the Library including whatever changes were used in the work (which must be distributed under Sections 1 and 2 above); and, if the work is an executable linked with the Library, with the complete machine-readable "work that uses the Library", as object code and/or source code, so that the user can modify the Library and then relink to produce a modified executable containing the modified Library. (It is understood that the user who changes the contents of definitions files in the Library will not necessarily be able to recompile the application to use the modified definitions.)

b) Use a suitable shared library mechanism for linking with the Library. A suitable mechanism is one that (1) uses at run time a copy of the library already present on the user's computer system, rather than copying library functions into the executable, and (2) will operate properly with a modified version of the library, if the user installs one, as long as the modified version is interface-compatible with the version that the work was made with.

c) Accompany the work with a written offer, valid for at least three years, to give the same user the materials specified in Subsection 6a, above, for a charge no more than the cost of performing this distribution.

d) If distribution of the work is made by offering access to copy from a designated place, offer equivalent access to copy the above specified materials from the same place.

e) Verify that the user has already received a copy of these materials or that you have already sent this user a copy.

For an executable, the required form of the "work that uses the Library" must include any data and utility programs needed for reproducing the executable from it. However, as a special exception, the materials to be distributed need not include anything that is normally distributed (in either source or binary form) with the major components (compiler, kernel, and so on) of the operating system on which the executable runs, unless that component itself accompanies the executable.

It may happen that this requirement contradicts the license restrictions of other proprietary libraries that do not normally accompany the operating system. Such a contradiction means you cannot use both them and the Library together in an executable that you distribute.

7. You may place library facilities that are a work based on the Library side-by-side in a single library together with other library facilities not covered by this License, and distribute such a combined library, provided that the separate distribution of the work based on the Library and of the other library facilities is otherwise permitted, and provided that you do these two things:

a) Accompany the combined library with a copy of the same work based on the Library, uncombined with any other library facilities. This must be distributed under the terms of the Sections above.

b) Give prominent notice with the combined library of the fact that part of it is a work based on the Library, and explaining where to find the accompanying uncombined form of the same work.

8. You may not copy, modify, sublicense, link with, or distribute the Library except as expressly provided under this License. Any attempt otherwise to copy, modify, sublicense, link with, or distribute the Library is void, and will automatically terminate your rights under this License. However, parties who have received copies, or rights, from you under this License will not have their licenses terminated so long as such parties remain in full compliance.

9. You are not required to accept this License, since you have not signed it. However, nothing else grants you permission to modify or distribute the Library or its derivative works. These actions are prohibited by law if you do not accept this License. Therefore, by modifying or distributing the Library (or any work based on the Library), you indicate your acceptance of this License to do so, and all its terms and conditions for copying, distributing or modifying the Library or works based on it.

10. Each time you redistribute the Library (or any work based on the Library), the recipient automatically receives a license from the original licensor to copy, distribute, link with or modify the Library subject to these terms and conditions. You may not impose any further restrictions on the recipients' exercise of the rights granted herein. You are not responsible for enforcing compliance by third parties with this License.

11. If, as a consequence of a court judgment or allegation of patent infringement or for any other reason (not limited to patent issues), conditions are imposed on you (whether by court order, agreement or otherwise) that contradict the conditions of this License, they do not excuse you from the conditions of this License. If you cannot distribute so as to satisfy simultaneously your obligations under this License and any other pertinent obligations, then as a consequence you may not distribute the Library at all. For example, if a patent license would not permit royalty-free redistribution of the Library by all those who receive copies directly or indirectly through you, then the only way you could satisfy both it and this License would be to refrain entirely from distribution of the Library.

If any portion of this section is held invalid or unenforceable under any particular circumstance, the balance of the section is intended to apply, and the section as a whole is intended to apply in other circumstances.

It is not the purpose of this section to induce you to infringe any patents or other property right claims or to contest validity of any such claims; this section has the sole purpose of protecting the integrity of the free software distribution system which is implemented by public license practices. Many people have made generous contributions to the wide range of software distributed through that system in reliance on consistent application of that system; it is up to the author/donor to decide if he or she is willing to distribute software through any other system and a licensee cannot impose that choice.

This section is intended to make thoroughly clear what is believed to be a consequence of the rest of this License.

12. If the distribution and/or use of the Library is restricted in certain countries either by patents or by copyrighted interfaces, the original copyright holder who places the Library under this License may add an explicit geographical distribution limitation excluding those countries, so that distribution is permitted only in or among countries not thus excluded. In such case, this License incorporates the limitation as if written in the body of this License.

13. The Free Software Foundation may publish revised and/or new versions of the Lesser General Public License from time to time. Such new versions will be similar in spirit to the present version, but may differ in detail to address new problems or concerns.

Each version is given a distinguishing version number. If the Library specifies a version number of this License which applies to it and "any later version", you have the option of following the terms and conditions either of that version or of any later version published by the Free Software Foundation. If the Library does not specify a license version number, you may choose any version ever published by the Free Software Foundation.

14. If you wish to incorporate parts of the Library into other free programs whose distribution conditions are incompatible with these, write to the author to ask for permission. For software which is copyrighted by the Free Software Foundation, write to the Free Software Foundation; we sometimes make exceptions for this. Our decision will be guided by the two goals of preserving the free status of all derivatives of our free software and of promoting the sharing and reuse of software generally.

Open Source software

NO WARRANTY

15. BECAUSE THE LIBRARY IS LICENSED FREE OF CHARGE, THERE IS NO WARRANTY FOR THE LIBRARY, TO THE EXTENT PERMITTED BY APPLICABLE LAW. EXCEPT WHEN OTHERWISE STATED IN WRITING THE COPYRIGHT HOLDERS AND/OR OTHER PARTIES PROVIDE THE LIBRARY "AS IS" WITHOUT WARRANTY OF ANY KIND, EITHER EXPRESSED OR IMPLIED, INCLUDING, BUT NOT LIMITED TO, THE IMPLIED WARRANTIES OF MERCHANTABILITY AND FITNESS FOR A PARTICULAR PURPOSE. THE ENTIRE RISK AS TO THE QUALITY AND PERFORMANCE OF THE LIBRARY IS WITH YOU. SHOULD THE LIBRARY PROVE DEFECTIVE, YOU ASSUME THE COST OF ALL NECESSARY SERVICING, REPAIR OR CORRECTION.

16. IN NO EVENT UNLESS REQUIRED BY APPLICABLE LAW OR AGREED TO IN WRITING WILL ANY COPYRIGHT HOLDER, OR ANY OTHER PARTY WHO MAY MODIFY AND/OR REDISTRIBUTE THE LIBRARY AS PERMITTED ABOVE, BE LIABLE TO YOU FOR DAMAGES, INCLUDING ANY GENERAL, SPECIAL, INCIDENTAL OR CONSEQUENTIAL DAMAGES ARISING OUT OF THE USE OR INABILITY TO USE THE LIBRARY (INCLUDING BUT NOT LIMITED TO LOSS OF DATA OR DATA BEING RENDERED INACCURATE OR LOSSES SUSTAINED BY YOU OR THIRD PARTIES OR A FAILURE OF THE LIBRARY TO OPERATE WITH ANY OTHER SOFTWARE), EVEN IF SUCH HOLDER OR OTHER PARTY HAS BEEN ADVISED OF THE POSSIBILITY OF SUCH DAMAGES.

END OF TERMS AND CONDITIONS

How to Apply These Terms to Your New Libraries

If you develop a new library, and you want it to be of the greatest possible use to the public, we recommend making it free software that everyone can redistribute and change. You can do so by permitting redistribution under these terms (or, alternatively, under the terms of the ordinary General Public License).

To apply these terms, attach the following notices to the library. It is safest to attach them to the start of each source file to most effectively convey the exclusion of warranty; and each file should have at least the "copyright" line and a pointer to where the full notice is found.

<one line to give the library's name and a brief idea of what it does.>

Copyright© <year> <name of author>

This library is free software; you can redistribute it and/or modify it under the terms of the GNU Lesser General Public License as published by the Free Software Foundation; either version 2.1 of the License, or (at your option) any later version.

This library is distributed in the hope that it will be useful, but WITHOUT ANY WARRANTY; without even the implied warranty of MERCHANTABILITY or FITNESS FOR A PARTICULAR PURPOSE. See the GNU Lesser General Public License for more details.

You should have received a copy of the GNU Lesser General Public License along with this library; if not, write to the Free Software Foundation, Inc., 51 Franklin Street, Fifth Floor, Boston, MA 02110-1301 USA

Also add information on how to contact you by electronic and paper mail.

You should also get your employer (if you work as a programmer) or your school, if any, to sign a "copyright disclaimer" for the library, if necessary. Here is a sample; alter the names:

Yoyodyne, Inc., hereby disclaims all copyright interest in the library 'Frob' (a library for tweaking knobs) written by James Random Hacker.

<signature of Ty Coon>, 1 April 1990

Ty Coon, President of Vice

That's all there is to it!

Index

A

- Activating
 - alarm clock 40
- Activating/deactivating
 - function 16
- Activating/deactivating microphone
 - (handset) 22
- Activating/deactivating silent alert 25
- Activating/deactivating
 - the crescendo tone
 - reminder signal 39
 - ring tone 24
- Activating/deactivating the key tone 8
- Activating/deactivating the key
 - vibration 8
- Advisory tones 25
- Alarm 40
- Alarm clock
 - activating/deactivating 40
- Alphanumeric keypad 8
- Anniversary, see Birthday
- Answering machine list 10
- Applications
 - adding to config. page 9
 - deleting from config. Page 9
 - selectable for config. page 10
- Applications menu 13
- Appointment
 - deleting missed 40
 - displaying missed 40
 - setting 39
- Area code
 - setting own area code 23
- Arrow in option slider 15
- Authorisation 51
- Auto answer 24

B

- Baby phone call 39
- Back function 16, 17
- Backlight timeout, display 23
- Backlight, display 23
- Base
 - changing 28
- Battery
 - charging 6
 - charging status 45
 - inserting 5

- Battery charging status 45
- Battery warning 25
- Best base 28
- Birthday 33
 - deleting missed 40
 - displaying missed 40
 - missed 40
 - saving to Contacts 33
- Bluetooth
 - accepting call 32
 - activating 30, 31
 - calling with a headset 32
 - changing device name 31, 32
 - ending a search 31
 - list of known devices 31
 - registering devices 30
 - starting a search 31
 - transferring Contacts (vCard) 36
 - transferring vCards 36

C

- Calendar 39
- Call
 - accepting 20
 - accepting (Bluetooth) 32
 - answering automatically 24
 - external 19
 - internal 29
 - internal transfer (connecting) 29
 - protection from undesired 25
 - transferring (connecting) 29
- Call list 20, 38
 - deleting an entry 11
 - deleting entire lists 12
 - deleting the entire list 12
 - dialling with 20
- Call swapping
 - internal/external call 29
- Call waiting
 - external during internal call 20
 - internal during external call 20
- Caller picture 34, 42
- Calling
 - external 19
 - internal 29
- Calling Line Identification 21
- Changing device name (Bluetooth) .. 31, 32
- Changing display page 8, 13
- Changing page 8, 13
- Changing settings
 - user interface elements 16

Index

Changing telephone settings	23
Changing the character set	18
Changing the keypad layout	18
Changing the settings	23
Character set	
Cyrillic	18
Greek	17
Charger cradle	
setting up	4
Charger cradle (handset)	
connecting	4
Charging contacts	1
Charging time of handset	54
Check	
data security of DECT connection	22
Checking service information	12, 51
CLIP	21
CLIP picture see caller picture	
Cloud synchronisation	43
CNIP	21
Conference	
ending	29
internal/external call	29
Configurable page (idle display)	9
configuring	9
deleting application/function	9
inserting application/function	9
selectable applications/functions	10
Connecting to base	28
Consultation call	
internal	29
Contact with liquid	53
Contacts	33
copying number from text	36
creating entry	33
deleting all entries	12
managing entries	33
opening	33
order of entries	34
saving birthdays	33
saving entry	33
sending entry/list to handset	35
sending to handset	35
sending vCards with Bluetooth	36
transferring vCards with Bluetooth	36
using to enter numbers	37
Correcting incorrect entries	17
Customer Care	49
Customer Service & Assistance	49

D

Deactivating	
alarm clock	40
baby phone call	42
Deleting	
lists	12
QuickDial	37
Destination number	
(baby phone call)	42
Dial page (idle display)	8
Dialling	
using the call list	20
using the redial list	19
with Contacts	20
Dialling page (idle display)	19
Display	
backlight	23
contacts memory	34
in idle status	8
network mailbox message	11, 27
number (CLI/CLIP)	21
screensaver	23
setting	23
timeout for backlight	23
Display icons	44
Display lock	
activating/deactivating	14
automatic	14
Displaying	
missed appointments/birthdays	40
Disposal	52

E

Earpiece mode	21
Earpiece volume	22
ECO DECT	26
End call/end key	1, 13, 19
End key, see End call/end key	
Entering diacritical characters	17
Entering special characters	17
Entering text	17
Entering umlauts	17
Entry in Contacts	33
Environment	52
Exclusion of liability	51
External call	
internal transfer (connecting)	29
External calls	
time control for ring tone	25

- F**
- Firmware
 - checking version 51
 - updating the handset
(Gigaset QuickSync) 43
 - Function
 - activating/deactivating 16
 - selecting 15
- G**
- Getting started 4
 - Gigaset QuickSync 43
 - GNU General Public License (GPL)
 - English 55
 - GNU Lesser General Public License
(LGPL), English 55
 - GPL 55
 - Green dot 12, 19, 20
 - Group call 29
- H**
- Handset
 - activating/deactivating 14
 - advisory tones 25
 - changing settings 23
 - changing to best reception 28
 - changing to different base 28
 - checking service information 12
 - connecting charger cradle 4
 - display backlight 23
 - display language 23
 - earpiece volume 22
 - idle display 8
 - idle status 14
 - in idle status 8
 - muting 22
 - registering 6
 - registering to different base 28
 - reset 26
 - restoring to default settings 26
 - screensaver 23
 - setting 23
 - setting up 5
 - speaker volume 22
 - transferring a call 29
 - using baby phone call 39
 - using multiple 28
 - Handset + base 6
 - Handset operating time
 - in baby phone call mode 41
 - Handsfree volume 22
 - Headset (Bluetooth) 32
 - accepting a call 32
 - Hearing aids 3
 - Help 50
- I**
- Icons
 - displaying new messages 11
 - options bar 44
 - status bar 45
 - Idle display
 - changing page 8, 13
 - configurable page 9
 - dial page 8
 - handset 8
 - messages page 10
 - Idle status
 - handset 8
 - returning to 14
 - Incorrect entry correction 17
 - Internal
 - making calls 29
 - Internal call 29
 - call waiting 20
 - Internal consultation call 29
- K**
- Key lock
 - automatic 14
 - Keypad
 - alphanumeric 8
 - with R / P 8
 - Keypad lock
 - activating/deactivating 14
 - Keypad/display lock on/off 1, 14
 - Keys
 - end call/end key 1, 19
 - handset 1
 - menu key 1
 - talk key 1, 19, 20

Index

- L**
- Language + region 23
 - License
 - GPL 55
 - LGPL 55
 - Liquid 53
 - List
 - accepted calls 38
 - answering machine 10
 - call lists 38
 - cleaning up 12, 34, 40
 - deleting 12
 - known devices (Bluetooth) 31
 - missed calls 38
 - network mailbox 10
 - opening via message pop-up 11
 - outgoing calls 38
 - scrolling in 15
 - selecting entry 15
 - SMS incoming list 10
 - List entry 11
 - Lock
 - activating/deactivating 14
 - automatic 14
 - Lower/upper case 17
- M**
- Main menu settings 46
 - Making calls
 - accepting a call 20
 - external 19
 - internal 29
 - Media pool 42
 - Medical equipment 3
 - Melody
 - ring tone for internal/external calls ... 24
 - Memory space in Contacts 34
 - Menu
 - applications 13
 - changing page 8, 13
 - opening 13
 - returning to idle status 13
 - Menu key 1, 13
 - Menu settings 46
 - Message LED 1, 11
 - Message list
 - opening 10
 - Message page (idle display) 10
 - Message pop-up 11
 - closing 11
 - Messages
 - deleting 11
 - Microphone sensitivity 22
 - Mini USB connection socket 1
 - Missed birthdays/appointments 40
 - Missed calls 38
 - Muting the handset 22
- N**
- Navigation area 1, 8, 13
 - Network mailbox 27
 - Number
 - as destination for baby phone call ... 42
 - copying to Contacts 36
 - displaying caller's number (CLIP) 21
 - entering with Contacts 37
 - preferred 37
 - saving in Contacts 33
 - Numbers
 - entering 17
- O**
- Opening the submenu 17
 - Operating time of handset 54
 - Option slider
 - showing/hiding 16
 - Options 15
 - Options bar 15
 - icons 44
 - Order in Contacts 34
 - Overview
 - setting options 46
 - Own page (idle display)
 - deleting application/function 9
 - inserting application/function 9
 - selectable applications/functions 10

- P**
- Package contents 4
 - Parameter 16
 - PC Interface 43
 - Phone
 - operating 14
 - restoring to factory settings..... 26
 - setting 23
 - Phone number display, notes 21
 - Picture
 - caller..... 42
 - Power adapter 3
 - Preferred number 33, 37
 - Protection from undesired calls..... 25
 - Proximity sensor 1, 14
- Q**
- Questions and answers 50
 - Quick access
 - to functions/applications 9
 - QuickDial
 - configuring..... 37
 - QuickDial shortcut 38
 - QuickSync 43
- R**
- Range 4
 - Redial list
 - dialling with 19
 - Reducing radiation 26
 - Reducing transmission power 26
 - Registering (handset)..... 6
 - Registering device (Bluetooth) 30
 - Reminder signal..... 39
 - activating/deactivating crescendo
 - tone 39
 - setting volume..... 39
 - Reset
 - handset 26
 - Ring tone
 - activating/deactivating crescendo
 - tone 24
 - changing..... 24
 - melody for internal/external calls..... 24
 - setting volume..... 24
 - time control for external calls 25
- S**
- Safety precautions 3
 - Screensaver 23, 42
 - Scrolling
 - horizontally 15
 - in lists..... 15
 - vertical..... 15
 - Searching
 - Bluetooth devices..... 30
 - in Contacts 35
 - Secure connection to base 22
 - Security check
 - handset/base connection..... 22
 - Selecting entry from Contacts..... 35
 - Selection fields..... 17
 - Sending
 - complete Contacts to handset 35
 - Contacts entry to handset 35
 - vCards with Bluetooth..... 36
 - Setting options
 - overview 46
 - Setting the display language..... 23
 - Setting the keypad 8
 - Setting up, handset 5
 - Settings menu 46
 - Settings options
 - telephone 23
 - Signal strength..... 45
 - Signal tone, see Advisory tones
 - Snooze mode (alarm)..... 41
 - Sound, see Ring tone
 - Speaker 21
 - Speaker profile..... 24
 - Specifications..... 53
 - Speed dial 10
 - Speed dial, see QuickDial
 - Status bar 1, 12
 - icons..... 45
 - Status page..... 12
 - opening/closing 12
 - Switch 16
 - Switching off wireless module..... 26
 - Switching on/off
 - function..... 16
 - Synchronising Contacts..... 43
 - Synchronising Google contacts..... 43

Index

T

- Talk key 1, 19, 20
- 3-way conference
 - ending 29
 - internal/external call 29
- Time control
 - ring tone for external calls 25
- Timeout for display backlight 23
- Tones + signals 24, 25
- Touchscreen 1
 - operating 15
- Transferring (internal)
 - external call 29
- Troubleshooting
 - general 50

U

- Unknown 21
- Unknown caller 21
- Unprotected connection to base 22
- Upper/lower case 17
- USB connection socket 1
- User interface elements 16
- Using the redial list 19

V

- vCard
 - receiving with Bluetooth 36
 - sending with Bluetooth 36
- Vertical scrolling 15
- Vibration, key 8
- Viewing network mailbox message .. 11, 27
- VIP ring tone 33, 34
- Volume
 - handsfree/earpiece volume of
 - handset 22
 - reminder signal 39
 - ring tone 24

W

- Warning tone, see Advisory tones

Issued by

Gigaset Communications GmbH
Frankenstr. 2a, D-46395 Bocholt

© Gigaset Communications GmbH 2012

Subject to availability.

All rights reserved. Rights of modification reserved.

www.gigaset.com